











# EVENT TECHNOLOGY

## MIDNIGHT-SERIES

		Page
	<b>Plugs</b>	<b>226</b>
	<b>Flanged plugs</b>	<b>226</b>
	<b>Connectors</b>	<b>228</b>
	<b>Flanged sockets</b>	<b>228</b>
	<b>Socket outlet (DIN 49440)</b>	<b>232</b>
	<b>T-Connect</b>	<b>236</b>
	<b>H-Connect</b>	<b>237</b>
	<b>Distribution boxes</b>	<b>238</b>
	<b>Hinged windows</b>	<b>239</b>

■ Version in black (similar to RAL9005)



# Event technology MIDNIGHT-SERIES

## Plug IP44 SHARK

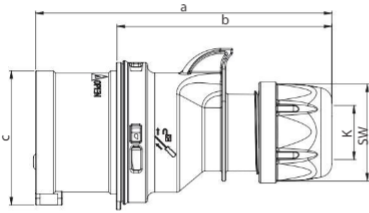

	16 Amp			32 Amp		
	3	4	5	3	4	5
<b>Poles</b>	3	4	5	3	4	5
<b>a [mm]</b>	122	128	134	150	150	155
<b>b [mm]</b>	86	92	98	104	104	109
<b>c [mm]</b>	47	53	61	63	63	70
<b>K_cable Ø [mm]</b>	6-15	6-15	8-16	11,5-20	11,5-20	11,5-22
<b>Wire flexible [mm<sup>2</sup>]</b>	1-2,5			2,5-6		
<b>Contact screws [Ncm]</b>	100			110		
<b>SW [mm]</b>	42	42	42	50	50	50
<b>Weight [g]</b>	109	128	151	181	201	232

- with screw terminals
- housing material: PA6
- contacts: brass
  - to order nickel-plated contacts please add a "v" e.g. 015-6xv

**IP44** splashproof

also available in IP67

## Plug IP44 SHARK TT

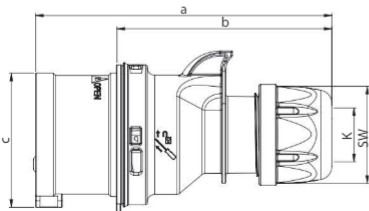

	16 Amp			32 Amp		
	3	4	5	3	4	5
<b>Poles</b>	3	4	5	3	4	5
<b>a [mm]</b>	122	128	134	150	150	155
<b>b [mm]</b>	86	92	98	104	104	109
<b>c [mm]</b>	47	53	61	63	63	70
<b>K_cable Ø [mm]</b>	6-15	6-15	8-16	11,5-20	11,5-20	11,5-22
<b>Wire flexible [mm<sup>2</sup>]</b>	1-2,5			2,5-6		
<b>SW [mm]</b>	42	42	42	50	50	50
<b>Weight [g]</b>	111	132	156	186	206	241

- screwless connection technology
- housing material: PA6
- contacts: brass
  - to order nickel-plated contacts please add a "v" e.g. 015-6TTxv

**IP44** splashproof

also available in IP67

## Plug IP67 POWERTWIST

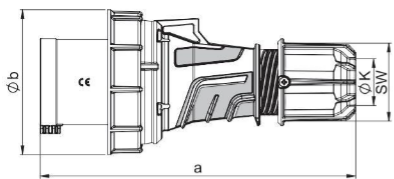

	63 Amp			125 Amp		
	3	4	5	3	4	5
<b>Poles</b>	3	4	5	3	4	5
<b>a [mm]</b>	250	250	250	270	270	270
<b>b [mm]</b>	115	115	115	131	131	131
<b>K_cable Ø [mm]</b>	14,5-36	14,5-36	14,5-36	22,5-50	22,5-50	22,5-50
<b>Wire flexible [mm<sup>2</sup>]</b>	6-16			16-50		
<b>Contact screws [Ncm]</b>	200			450		
<b>SW [mm]</b>	61	61	61	81	81	81
<b>Weight [g]</b>	574	621	670	956	1064	1169

- Contact frame with screws (63A) for 125A with hexagon socket screws
- housing material: PA6
- contacts: nickel-plated contacts, with pilot contact (see page 8)

**IP66/67** watertight

## Flanged plug straight IP44

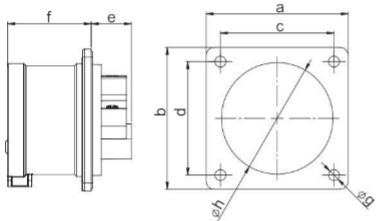

	16 Amp			32 Amp		
	3	4	5	3	4	5
<b>Poles</b>	3	4	5	3	4	5
<b>Flange a x b [mm]</b>	70	70	70	70	70	70
<b>Fixing center c x d [mm]</b>	56	56	56	56	56	56
<b>e [mm]</b>	21	21	20	21	21	21
<b>f [mm]</b>	42	42	42	51	51	51
<b>g [mm]</b>	5,5	5,5	5,5	5,5	5,5	5,5
<b>h [mm]</b>	43	43	55	55	55	55
<b>Wire flexible [mm<sup>2</sup>]</b>	1-2,5			2,5-6		
<b>Wire solid [mm<sup>2</sup>]</b>	1-4			2,5-10		
<b>Contact screws [Ncm]</b>	100			110		
<b>Weight [g]</b>	86	101	118	125	145	165

- with screw terminals
- housing material: PA6
- contacts: brass
  - to order nickel-plated contacts please add a "v" e.g. 615-6xv
- According to EN 60309: For correct use a locking device has to be provided (see page 10)

**IP44** splashproof

## Flanged plug straight IP67 TT

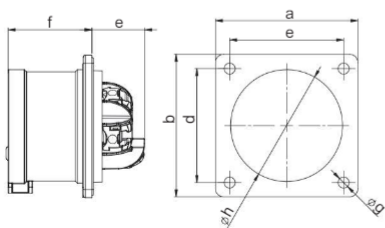

	16 Amp		32 Amp	
	3	5	4	5
<b>Poles</b>	3	5	4	5
<b>Flange a x b [mm]</b>	70	70	70	70
<b>Fixing center c x d [mm]</b>	56	56	56	56
<b>e [mm]</b>	26	26	29	29
<b>f [mm]</b>	42	42	51	51
<b>g [mm]</b>	5,5	5,5	5,5	5,5
<b>h [mm]</b>	43	55	55	55
<b>Wire flexible [mm<sup>2</sup>]</b>	1-2,5		2,5-6	
<b>Wire solid [mm<sup>2</sup>]</b>	1-4		2,5-10	
<b>Weight [g]</b>	89	122	151	172

- screwless connection technology
- housing material: PA6
- contacts: brass
  - to order nickel-plated contacts please add a "v" e.g. 615-6TTxv
- According to EN 60309: For correct use a locking device has to be provided (see page 10)

**IP44** splashproof

Amp.	Poles	pack. unit	230V~	400V~
			50/60Hz 3p=6h 4p+5p=9h	50/60Hz 3p=9h 4p+5p=6h
			Cat.No.	Cat.No.

16	3	10
16	4	10
16	5	10
32	3	10
32	4	10
32	5	10

013-6x	014-6x 015-6x
023-6x	024-6x 025-6x



023-6x

16	3	10
16	4	10
16	5	10
32	3	10
32	4	10
32	5	10

013-6TTx	014-6TTx 015-6TTx
023-6TTx	024-6TTx 025-6TTx



015-6TTx

63	3	2
63	4	2
63	5	2
125	3	2
125	4	2
125	5	2

033-6xs	034-6xs 035-6xs
043-6xs	044-6xs 045-6xs



035-6xs

with flange 70 x 70 - fixing center 56 x 56

16	3	10
16	4	10
16	5	10
32	3	10
32	4	10
32	5	10

613-6x	614-6x 615-6x
623-6x	624-6x 625-6x



625-6x

with flange 70 x 70 - fixing center 56 x 56

16	3	10
16	5	10
32	4	10
32	5	10

613-6TTx	615-6TTx
624-6TTx	625-6TTx



625-6TTx

Minimum order quantity: 50 pcs.

- 
- 
- 
- 
- 
- 
- 
- 
- 
-

# Event technology MIDNIGHT-SERIES

## Connector IP44

### SHARK

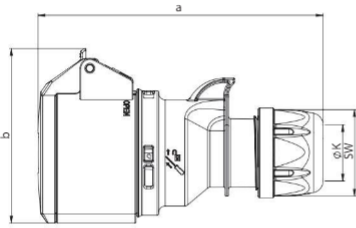

	16 Amp			32 Amp		
	3	4	5	3	4	5
<b>Poles</b>	3	4	5	3	4	5
<b>a [mm]</b>	133	138	145	161	161	168
<b>b [mm]</b>	76	80	89	91	94	100
<b>K cable Ø [mm]</b>	6-15	6-15	8-16	11,5-20	11,5-20	11,5-22
<b>Wire flexible [mm<sup>2</sup>]</b>	1-2,5			2,5-6		
<b>Contact screws [Ncm]</b>	100			110		
<b>SW [mm]</b>	42	42	42	50	50	50
<b>Weight [g]</b>	134	161	180	228	244	270

- with screw terminals
- housing material: PA6
- contacts: brass
  - to order nickel-plated contacts please add a "v" e.g. 215-6xv

**IP44** splashproof

also available in IP67

## Connector IP44

### SHARK TT

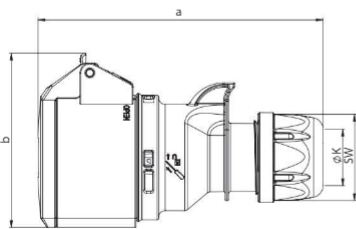

	16 Amp			32 Amp		
	3	4	5	3	4	5
<b>Poles</b>	3	4	5	3	4	5
<b>a [mm]</b>	133	138	145	161	161	168
<b>b [mm]</b>	76	82	89	94	94	100
<b>K cable Ø [mm]</b>	6-15	6-15	8-16	11,5-20	11,5-20	11,5-22
<b>Wire flexible [mm<sup>2</sup>]</b>	1-2,5			2,5-6		
<b>SW [mm]</b>	42	42	42	50	50	50
<b>Weight [g]</b>	136	161	193	228	243	271

- screwless connection technology
- housing material: PA6
- contacts: brass
  - to order nickel-plated contacts please add a "v" e.g. 215-6TTxv

**IP44** splashproof

also available in IP67

## Connector IP66/67

### POWER TWIST

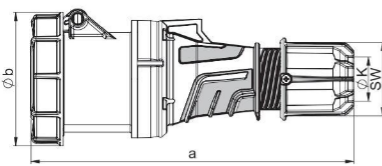

	63 Amp			125 Amp		
	3	4	5	3	4	5
<b>Poles</b>	3	4	5	3	4	5
<b>a [mm]</b>	269	269	269	287	287	287
<b>b [mm]</b>	114	114	114	124	124	124
<b>K cable Ø [mm]</b>	14,5-36	14,5-36	14,5-36	22,5-50	22,5-50	22,5-50
<b>Wire flexible [mm<sup>2</sup>]</b>	6-16			16-50		
<b>Contact screws [Ncm]</b>	200			450		
<b>SW [mm]</b>	61	61	61	81	81	81
<b>Weight [g]</b>	673	714	772	1060	1167	1266

- Contact frame with screws for 125A with hexagon socket screws
- housing material: PC/ABS
- contacts: brass with lamellar contact CuBe
  - to order with pilot contact please add a „5“ e.g. 2335-6xs (see page 8)
  - to order with pilot contact system (PCS) please add a „6“ e.g. 2336-6xs (see page 8)

**IP66/67** watertight

## Flanged socket straight IP44

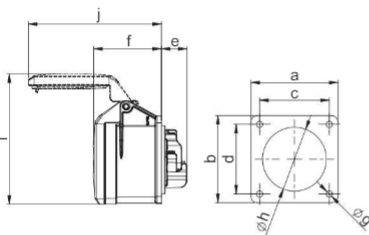

	16 Amp			32 Amp		
	3	4	5	3	4	5
<b>Poles</b>	3	4	5	3	4	5
<b>Flange a x b [mm]</b>	70	70	70	70	70	70
<b>Fixing center c x d [mm]</b>	56	56	56	56	56	56
<b>e [mm]</b>	21	21	21	23	23	23
<b>f [mm]</b>	55	55	55	67	67	67
<b>g [mm]</b>	5,5	5,5	5,5	5,5	5,5	5,5
<b>h [mm]</b>	43	45	55	55	55	58
<b>i [mm]</b>	87	101	105	112	112	108
<b>j [mm]</b>	101	101	107	122	122	136
<b>Wire flexible [mm<sup>2</sup>]</b>	1-2,5			2,5-6		
<b>Wire solid [mm<sup>2</sup>]</b>	1-4			2,5-10		
<b>Contact screws [Ncm]</b>	100			110		
<b>Weight [g]</b>	115	127	141	162	178	206

- with screw terminals
- housing material: PA6
- contacts: brass
  - to order nickel-plated contacts please add a "v" e.g. 315-6xv

**IP44** splashproof  
**IP44/54** 16/3; 16/5 and 32/5 are splash- and dustproof

also available in IP67

## Flanged socket straight IP44

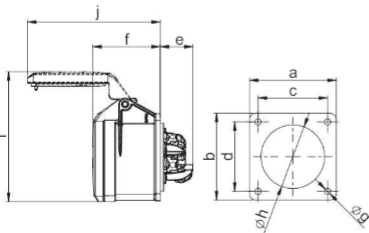

	16 Amp			32 Amp		
	3	4	5	3	4	5
<b>Poles</b>	3	4	5	3	4	5
<b>Flange a x b [mm]</b>	70	70	70	70	70	70
<b>Fixing center c x d [mm]</b>	56	56	56	56	56	56
<b>e [mm]</b>	27	27	27	27	27	27
<b>f [mm]</b>	55	55	55	67	67	67
<b>g [mm]</b>	5,5	5,5	5,5	5,5	5,5	5,5
<b>h [mm]</b>	43	45	55	55	55	58
<b>i [mm]</b>	87	101	105	112	112	108
<b>j [mm]</b>	101	101	107	122	122	136
<b>Wire flexible [mm<sup>2</sup>]</b>	1-2,5			2,5-6		
<b>Wire solid [mm<sup>2</sup>]</b>	1-4			2,5-10		
<b>Weight [g]</b>	117	128	146	161	178	207

- screwless connection technology
- housing material: PA6
- contacts: brass
  - to order nickel-plated contacts please add a "v" e.g. 315-6TTxv

**IP44** splashproof  
**IP44/54** 16/3; 16/5 and 32/5 are splash- and dustproof

also available in IP67



Amp.	Poles	pack. unit	230V~	400V~
			50/60Hz 3p=6h 4p+5p=9h	50/60Hz 3p=9h 4p+5p=6h
			Cat.No.	Cat.No.

16	3	10
16	4	10
16	5	10
32	3	10
32	4	10
32	5	10

213-6x	214-6x 215-6x
223-6x	224-6x 225-6x



223-6x

16	3	10
16	4	10
16	5	10
32	3	10
32	4	10
32	5	10

213-6TTx	214-6TTx 215-6TTx
223-6TTx	224-6TTx 225-6TTx



215-6TTx

63	3	2
63	4	2
63	5	2
125	3	2
125	4	2
125	5	2

233-6xs	234-6xs 235-6xs
243-6xs	244-6xs 245-6xs



235-6xs

with flange 70 x 70 - fixing center 56 x 56

16	3	10
16	4	10
16	5	10
32	3	10
32	4	10
32	5	10

313-6x	314-6x 315-6x
323-6x	324-6x 325-6x



315-6x

with flange 70 x 70 - fixing center 56 x 56

16	3	10
16	4	10
16	5	10
32	3	10
32	4	10
32	5	10

313-6TTx	314-6TTx 315-6TTx
323-6TTx	324-6TTx 325-6TTx



313-6TTx

Minimum order quantity: 50 pcs.

# Event technology MIDNIGHT-SERIES

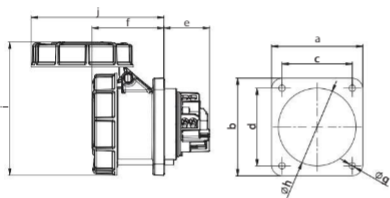

## Flanged socket straight 66/67 **POWER TWIST**

	63 Amp			125 Amp		
	3	4	5	3	4	5
<b>Poles</b>	3	4	5	3	4	5
<b>Flange a x b [mm]</b>	100	100	100	120	120	120
<b>Fixing center c x d [mm]</b>	80	80	80	100	100	100
<b>e [mm]</b>	50	50	50	48	48	48
<b>f [mm]</b>	80	80	80	101	101	101
<b>g [mm]</b>	7	7	7	8	8	8
<b>h [mm]</b>	85	85	85	90	90	90
<b>i [mm]</b>	147	147	147	159	159	159
<b>j [mm]</b>	146	146	146	179	179	179
<b>Wire flexible [mm<sup>2</sup>]</b>	6-16			16-50		
<b>Wire solid [mm<sup>2</sup>]</b>	6-25			16-70		
<b>Contact screws [Ncm]</b>	200			450		
<b>Weight [g]</b>	488	533	587	752	890	986

- Contact frame with screws (63A) for 125A with hexagon socket screws
- housing material: PA6
- contacts: brass with lamellar contact CuBe
  - to order with pilot contact please add a „5“ e.g. 3335-6xs (see page 8)
  - to order with pilot contact system (PCS) please add a „6“ e.g. 3336-6xs (see page 8)

**IP66/67** watertight

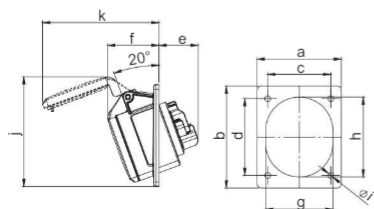

## Flanged socket sloping IP44

	16 Amp			32 Amp		
	3	4	5	3	4	5
<b>Poles</b>	3	4	5	3	4	5
<b>Flange a [mm]</b>	80	80	80	80	80	80
<b>Flange b [mm]</b>	97	97	97	97	97	97
<b>Fixing center c [mm]</b>	60	60	60	60	60	60
<b>Fixing center d [mm]</b>	73	73	73	73	73	73
<b>e [mm]</b>	38	38	38	48	48	48
<b>f [mm]</b>	47	47	49	54	54	55
<b>g [mm]</b>	51	56	65	65	65	70
<b>h [mm]</b>	61	67	76	75	75	80
<b>i [mm]</b>	5,5	5,5	5,5	5,5	5,5	5,5
<b>j [mm]</b>	97	103	105	105	105	99
<b>k [mm]</b>	99	104	111	119	119	130
<b>Wire flexible [mm<sup>2</sup>]</b>	1-2,5			2,5-6		
<b>Wire solid [mm<sup>2</sup>]</b>	1-4			2,5-10		
<b>Contact screws [Ncm]</b>	100			110		
<b>Weight [g]</b>	116	132	154	166	182	214

- with screw terminals
- housing material: PA6
- contacts: brass
  - to order nickel-plated contacts please add a "v" e.g. 415-6xv

**IP44** splashproof  
**IP44/54** 16/3; 16/5 and 32/5 are splash- and dustproof

also available in IP67

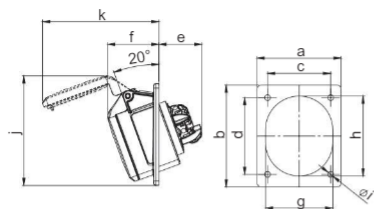

## Flanged socket sloping IP44 TT

	16 Amp			32 Amp		
	3	4	5	3	4	5
<b>Poles</b>	3	4	5	3	4	5
<b>Flange a [mm]</b>	80	80	80	80	80	80
<b>Flange b [mm]</b>	97	97	97	97	97	97
<b>Fixing center c [mm]</b>	60	60	60	60	60	60
<b>Fixing center d [mm]</b>	73	73	73	73	73	73
<b>e [mm]</b>	41	41	41	48	48	48
<b>f [mm]</b>	47	47	49	54	54	55
<b>g [mm]</b>	51	56	65	65	65	70
<b>h [mm]</b>	61	67	76	75	75	80
<b>i [mm]</b>	5,5	5,5	5,5	5,5	5,5	5,5
<b>j [mm]</b>	97	103	105	105	105	99
<b>k [mm]</b>	99	104	111	119	119	130
<b>Wire flexible [mm<sup>2</sup>]</b>	1-2,5			2,5-6		
<b>Wire solid [mm<sup>2</sup>]</b>	1-4			2,5-10		
<b>Weight [g]</b>	119	133	158	165	182	215

- screwless connection technology
- housing material: PA6
- contacts: brass
  - to order nickel-plated contacts please add a "v" e.g. 415-6TTxv

**IP44** splashproof  
**IP44/54** 16/3; 16/5 and 32/5 are splash- and dustproof

also available in IP67

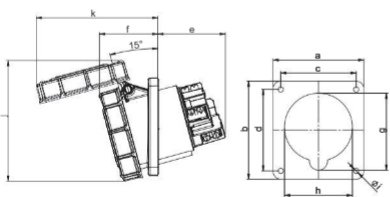

## Flanged socket sloping IP67 **POWER TWIST**

	63 Amp			125 Amp		
	3	4	5	3	4	5
<b>Poles</b>	3	4	5	3	4	5
<b>Flange a [mm]</b>	100	100	100	120	120	120
<b>Flange b [mm]</b>	112	112	112	130	130	130
<b>Fixing center c [mm]</b>	80	80	80	100	100	100
<b>Fixing center d [mm]</b>	88	88	88	108	108	108
<b>e [mm]</b>	64	64	64	92	92	92
<b>f [mm]</b>	80	80	80	77	77	77
<b>g [mm]</b>	92	92	92	102	102	102
<b>h [mm]</b>	82	82	82	90	90	90
<b>i [mm]</b>	7	7	7	7	7	7
<b>j [mm]</b>	148	148	148	160	160	160
<b>k [mm]</b>	154	154	154	162	162	162
<b>l [mm]</b>	154	154	154	162	162	162
<b>Wire flexible [mm<sup>2</sup>]</b>	6-16			16-50		
<b>Wire solid [mm<sup>2</sup>]</b>	6-25			16-70		
<b>Contact screws [Ncm]</b>	200			450		
<b>Weight [g]</b>	495	540	595	804	896	995

- Contact frame with screws (63A) for 125A with hexagon socket screws
- housing material: PA6
- contacts: brass with lamellar contact CuBe
  - to order with pilot contact please add a „5“ e.g. 4335-6xs (see page 8)
  - to order with pilot contact system (PCS) please add a „6“ e.g. 4336-6xs (see page 8)

**IP67** watertight



# Event technology MIDNIGHT-SERIES

## Socket outlet safety Austrian/German system

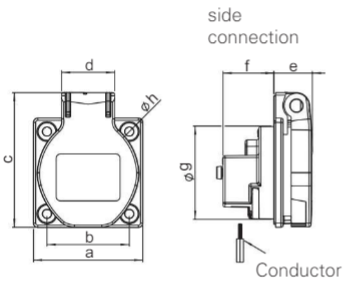

	• STANDARD •	
	16 Amp	
<b>Poles</b>	2P + E	
<b>Flange a</b> [mm]	50	
<b>Fixing center b</b> [mm]	38	
<b>c</b> [mm]	62	
<b>d</b> [mm]	25	
<b>e</b> [mm]	18	
<b>f</b> [mm]	24	
<b>g</b> [mm]	43	
<b>h</b> [mm]	4,2	
<b>Wire flexible</b> [mm <sup>2</sup> ]	1 - 2x2,5	
<b>Wire solid</b> [mm <sup>2</sup> ]	1 - 2x2,5	
<b>Contact screws</b> [Ncm]	80	
<b>Weight</b> [g]	45	

- with screw terminals
- housing material: PA6
- contacts: nickel-plated contacts

IP54 splashproof

## Socket outlet safety Austrian/German system with sealing bulge

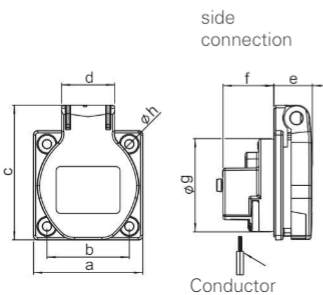

	• STANDARD •	
	16 Amp	
<b>Poles</b>	2P + E	
<b>Flange a</b> [mm]	50	
<b>Fixing center b</b> [mm]	38	
<b>c</b> [mm]	62	
<b>d</b> [mm]	25	
<b>e</b> [mm]	22	
<b>f</b> [mm]	24	
<b>g</b> [mm]	43	
<b>h</b> [mm]	4,2	
<b>Wire flexible</b> [mm <sup>2</sup> ]	1 - 2x2,5	
<b>Wire solid</b> [mm <sup>2</sup> ]	1 - 2x2,5	
<b>Contact screws</b> [Ncm]	80	
<b>Weight</b> [g]	45	

- with sealing bulge
- with screw terminals
- housing material: PA6
- contacts: nickel-plated contacts

IP54 splashproof



\* Plugs and socket outlets for portable use are subject to the standard DIN VDE 0620-1:2010 and ÖVE/ÖNORM E 8684-2-2:2010

## Socket outlet safety French/Belgian system

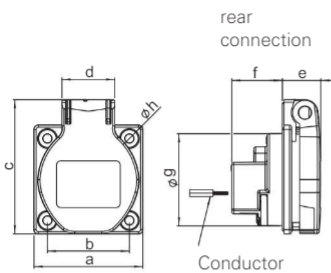

	• STANDARD •	
	16 Amp	
<b>Poles</b>	2P + E	
<b>Flange a</b> [mm]	50	
<b>Fixing center b</b> [mm]	38	
<b>c</b> [mm]	62	
<b>d</b> [mm]	25	
<b>e</b> [mm]	18	
<b>f</b> [mm]	24	
<b>g</b> [mm]	43	
<b>h</b> [mm]	4,2	
<b>Wire flexible</b> [mm <sup>2</sup> ]	1 - 2x2,5	
<b>Wire solid</b> [mm <sup>2</sup> ]	1 - 2x2,5	
<b>Contact screws</b> [Ncm]	80	
<b>Weight</b> [g]	45	

- with screw terminals
- housing material: PA6
- contacts: nickel-plated contacts
- with shutter

IP54 splashproof

## Socket outlet safety British system

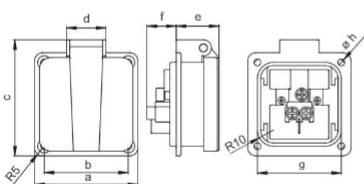

	13 Amp	13 Amp
<b>Poles</b>	2P + E	2P + E
<b>Flange a</b> [mm]	64	50
<b>Fixing center b</b> [mm]	52	38
<b>c</b> [mm]	72	54
<b>d</b> [mm]	25	25
<b>e</b> [mm]	26,5	18
<b>f</b> [mm]	18	22
<b>g</b> [mm]	52	35
<b>h</b> [mm]	4,2	4,5
<b>Weight</b> [g]	67	50

- with screw terminals
- housing material: PA6
- side connection

IP54 splashproof

250V~

50/60Hz

Amp.	Poles	pack. unit	Abbreviations/Types	Cat.No.
16	3	100	<p><b>P-NOVA PLUS+</b></p> <p>Flange: 50x50mm, Fixing center: 38x38mm</p>	1050-0ss
16	3	100	<p><b>P-NOVA PLUS+</b></p> <p>Flange: 50x50mm, Fixing center: 38x38mm</p>	1050-0ssw
16	3	100	<p><b>P-NOVA PLUS+</b></p> <p>Flange: 50x50mm, Fixing center: 38x38mm <b>without shutter</b></p>	1040-0s
16	3	100	<p>Flansch: 50x50mm, Lochabstand: 38x38mm <b>incl. shutter</b></p>	1040-0sc
13	3	100	Flange: 64x64mm, Fixing center: 52x52mm	1020-0s
13	3	100	Flange: 50x50mm, Fixing center: 38x38mm	1020-5s



1040-0s

1040-0s



1020-0s

1020-5s

- 
- 
- 
- 
- 
- 
- 
- 
- 
- 
- 
-



# Event technology MIDNIGHT-SERIES

**TAURUS**  
Der Schutzkontaktstecker



## Safety plug Dual earthing system

- Solid rubber version (TPE)
- Internal strain relief
- Contact carrier: TPE

IP54

**0522-ss**

pack.unit: 30

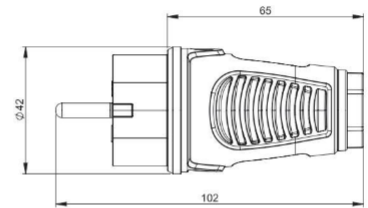

**TAURUS**  
Der Schutzkontaktstecker



## Safety connector with hinged lid Austrian/German system

- Solid rubber version (TPE)
- Internal strain relief
- Contact carrier: TPE

IP54

**2522-ss**

pack.unit: 20

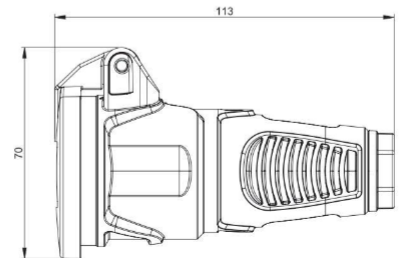

**TAURUS**  
Der Schutzkontaktstecker



## Safety connector with cap Austrian/German system

- Solid rubber version (TPE)
- Internal strain relief
- Contact carrier: TPE

IP54

**2521-ss**

pack.unit: 20

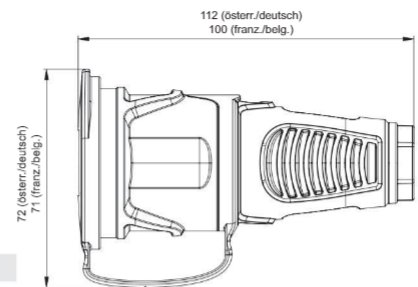

## 3-way connector rubber French/Belgian system

- with cap
- insert: polyamide

IP44 splashproof



**24311-sxs**

with shutter **24311-sxsc**

pack.unit: 5

Height= 57mm

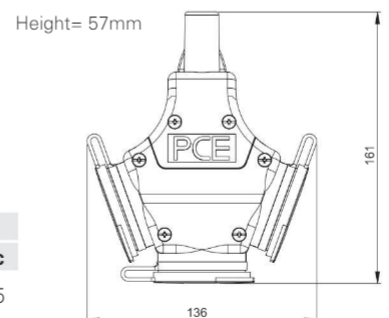

## Safety plug Dual earthing system

- schraubenlose zentrische Zugentlastung
- Oberfläche gummiert
- Einsatz: PA6

IP54 

**05721-ss**

pack.unit: 20

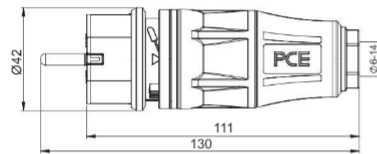



**TOPTAURUS<sup>2</sup>**  
Der Schutzkontaktstecker



## Safety connector with hinged lid Austrian/German system or French/Belgian system

- with screwless cable gland
- optional: LED power indicator, shutter
- rubberised surface
- insert: PA6

IP54 

		
standard	<b>25712-ss</b>	<b>24712-ss</b>
+ shutter	<b>25712-ssc</b>	<b>24712-ssc</b>
standard + LED	<b>25732-ss</b>	<b>24732-ss</b>
+ LED + shutter	<b>25732-ssc</b>	<b>24732-ssc</b>

pack.unit: 10

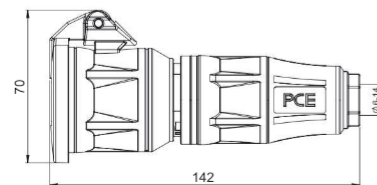



**TOPTAURUS<sup>2</sup>**  
Der Schutzkontaktstecker



## Safety connector with cap Austrian/German system or French/Belgian system

- with screwless cable gland
- optional: LED power indicator, shutter
- rubberised surface
- insert: PA6

IP54 

		
standard	<b>25711-ss</b>	<b>24711-ss</b>
+ shutter	<b>25711-ssc</b>	<b>24711-ssc</b>
standard + LED	<b>25731-ss</b>	<b>24731-ss</b>
+ LED + shutter	<b>25731-ssc</b>	<b>24731-ssc</b>

pack.unit: 10

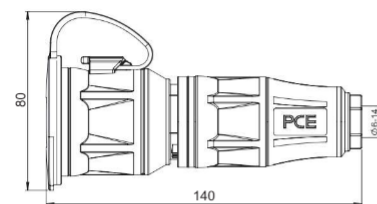

**TOPTAURUS<sup>2</sup>**  
Der Schutzkontaktstecker



## 3-way connector solid rubber Austrian/German system

- with hinged lid
- insert: rubber, • with screwless cable gland

IP44 splashproof 



 with LED power indicator

  
**253622-sxs**  
**253642-sxs**

pack.unit: 5

Height= 57mm

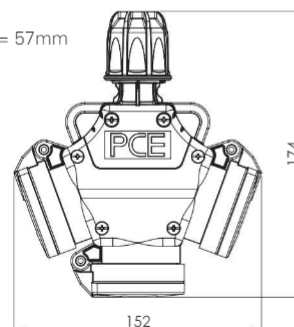

# Event technology MIDNIGHT-SERIES



94325000

94326000

## T-Connect

### Equipment:

- 1 CEE-plug 16A 3p 6h
- 1 CEE-socket 16A 3p 6h
- 1 cable exit  
(terminal block max. 3x2,5mm<sup>2</sup>)

**IP44** splashproof  
**IP67** watertight

**94325000**  
**94326000**

pack.unit: 10

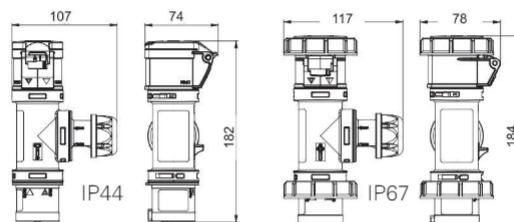

94325001

## T-Connect with cable

### Equipment:

- 1,5m cable H07RN-F 3G1,5 with CEE-plug 16A 3p 6h
- 1 cable entry  
(terminal block max. 3x2,5mm<sup>2</sup>)
- 1 CEE-socket 16A 3p 6h

**IP44** splashproof  
**IP67** watertight

**94325001**  
**94326001**

pack.unit: 10

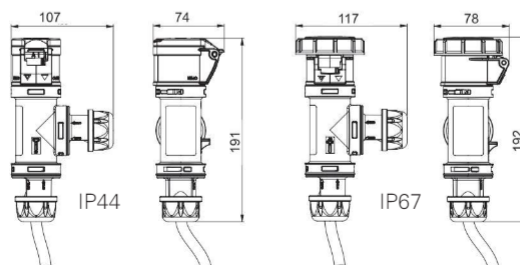

94325002

## T-Connect with cable entry

### Equipment:

- 1 cable entry  
(terminal block max. 3x2,5mm<sup>2</sup>)
- 2 CEE-sockets 16A 3p 6h outlet

**IP44** splashproof  
**IP67** watertight

**94325002**  
**94326002**

pack.unit: 10

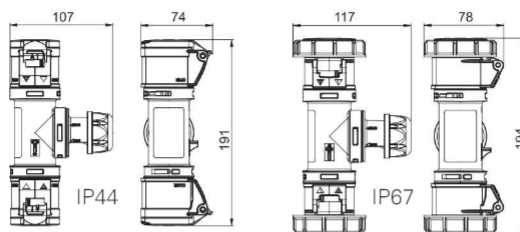

94325003

## T-Connect with CEE-plug

### Equipment:

- 1 CEE-plug 16A 3p 6h
- 2 CEE-sockets 16A 3p 6h outlet

**IP44** splashproof  
**IP67** watertight

**94325003**  
**94326003**

pack.unit: 10

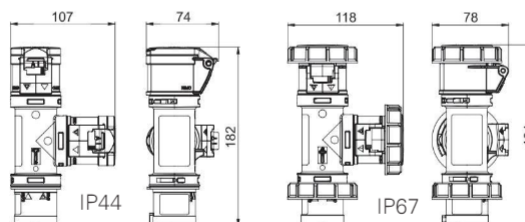



# H-CONNECT MIDNIGHT



## H-Connect

### CEE multiple socket

- incl. eyelet for velcro tape for mounting on round tubes
- housing material ABS
- contacts: brass nickel-plated

### Equipment:

- 1 CEE plug 16A 3p 6h
- 3 CEE socket 16A 3p 6h

IP44 splashproof

94327000

pack.unit: 10



optional: velcro tape



Eyelet for velcro tape

