

article#	327-6v
article description	CEE-flanged socket (70x70mm) 32A 7p 6h IP44/IP54
description long	CEE-flanged socket (70x70mm) 32A 7p 6h IP44/IP54 housing material: PA6 rated current: 32A number of poles: 7 (6P+PE) clock-position: 6h rated voltage/frequency: 380-415V~ / 50+60Hz contacts: brass nickel plated connection technology: screw terminals dimensions (flange/fixing center): 70x70 mm / 56x56 mm IP protection class: IP44/IP54
GTIN (EAN)	9003399047527
country of origin	AT
customs number	85366990
net weight	0.243 kg
packaging quantity	10
minimum order quantity	10

ETIM 9.0	EC001317
IEC-amperage	32 A
Voltage according to EN 60309-2	400 V (50+60 Hz) red
Number of poles	7
Clock hour position	6 h
Identification colour	Red
Degree of protection (IP)	IP54
Connection system	Screwed terminal
Angle of plug	Straight
Material	Plastic
Flange size vertical	70 mm
Drill hole distance vertical	56 mm
Flange size horizontal	70 mm
Drill hole distance horizontal	56 mm

a	70 mm
b	70 mm
c	56 mm
d	56 mm
e	28 mm
f	67 mm
g	5,5 mm
h	58 mm
i	108 mm
j	136 mm
wire flexible	2,5-6 mm ²
wire solid	2,5-10 mm ²
contact screws	110 Ncm
dismantling length	50 mm
stripping length	12-14 mm
ambient temperature	-25 – 40 °C
temperature resistance	-25 – 80 °C

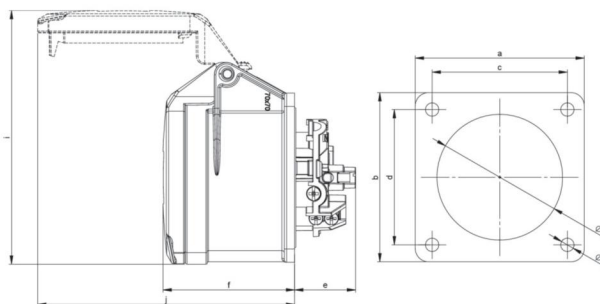





<https://www.pcelectric.at/shop/en/?func=detail&artnr=327-6v>

