

article#	61142-6
article description	CEE-switched interlocked socket compact 16A 4p 6h IP66/IP67
description long	CEE-switched interlocked socket compact 16A4p 6h IP66/IP67 housing material: PA6 + PC/ABS rated current: 16A number of poles: 4 (3P+PE) clock-position: 6h rated voltage/frequency: 380-415V~ / 50+60Hz contacts: brass nickel plated connection technology: screw terminals wall mounting, mechanical interlock switch: ON/OFF PCE-Merz ML0; EN 60947-3; AC22A, 10kA IP protection class: IP66/IP67
GTIN (EAN)	9003399174506
country of origin	AT
customs number	85366990
net weight	0.649 kg
packaging quantity	1
minimum order quantity	1

ETIM 9.0	EC001324
IEC-amperage	16 A
Number of poles	4
Voltage according to EN 60309-2	400 V (50+60 Hz) red
Clock hour position	6 h
Identification colour	Red
Degree of protection (IP)	IP67
Switch	Mechanical locking
Material housing	Plastic
Model	Base unit and cover
Contact material	CuZn
Surface treatment contacts	Nickel-plated

a	118 mm
wire flexible	1,5-2,5 mm ²
wire solid	1,5-4 mm ²
contact screws	120 Ncm
housing screws	110 Ncm
ambient temperature	-25 – 40 °C
temperature resistance	-25 – 80 °C

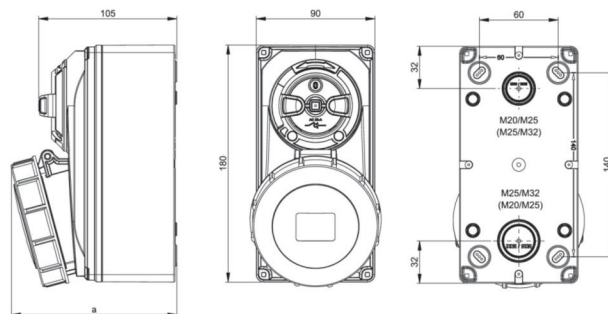





<https://www.pcelectric.at/shop/en/?func=detail&artnr=61142-6>