



# PowerSyntax® connectors

Inline and panel version,  
chain pilot with microswitch,  
compatible accessories

**SYNTAX®**



**VALENTINI**



## **Inventors, manufacturers, innovators.**

Valentini is a dynamic, ever-evolving company operating in over 60 countries worldwide. For more than 30 years we have actively researched, designed and manufactured connectors for power, signal and hybrid applications. Our Syntax connectors have been used all over the world to manage power and electric signals in fields such as industry, automotive, broadcasting, shipbuilding & ship to shore power, international sporting events, live shows, military & national emergency management by agencies such as the Italian Civil Protection Department, and so many more. Valentini is an environmentally-aware company where respect for the environment is an integral part of the manufacturing process. Our team is motivated and mindful of details, as we know details are important in our pursuit of uncompromised quality and utmost reliability.

# INDEX

## 04 PowerSyntax connectors series

General features  
 Typical applications  
 Technical data  
 Technical features  
 Drain IP2X 

## 06 Chain Pilot

Technical data pilot microswitch  
 Panel source and panel drain  
 Panel circuits  
 Contacts  
 Overall dimensions

## 10 Chain Pilot Box

Product overview  
 Technical features  
 Technical data  
 Possible configurations  
 Overall dimensions

## 14 Basic panel or shelter

Basic panel drain or source  
 Shelter panel connector  
 Panel mount cut-out options  
 Overall dimensions  
 Contacts and sleeve adapter system

## 18 Line connectors

Short body  
 Standard body  
 Oversize body  
 Contacts and crimping data  
 Overall dimensions

## 25 Phase inverters / Adaptors

## 26 S2W 480amp PowerSyntax

Multiplier | Adaptor | Phase inverter

## 28 Cable protection and management

Wire mesh strain relief | Hanger grip | Pulling grip

## 30 Protection caps and SyntaxLock

## 32 Part Number



# PowerSyntax® connectors series

## PowerSyntax family of Powerlock-style single pole connectors.

**SPX, SPZ, SPY** and **SPV** are the new PowerSyntax series of Powerlock compatible single pole electrical connectors. Power Syntax are specifically suited for the electrical supply management from **480amp** up to **750amp**. Although fully intermateable with the original (and all the previous Syntax versions), the new PowerSyntax features a number of mechanical and technical enhancements which have been designed and incorporated to redefine the standards on this category of connectors as for safety, reliability, ease of handling and robustness in the harshest conditions.

## General features

- Powerlock compatible
- Intermateable with other versions
- CE compliant
- EN/ESI compliant
- Contact retained within the thermoplastic housing with a flame-retardant UL94-VO plastic pin.
- Quick assembling and disassembling, no special extracting tools are needed
- Heavy-duty ergonomic hand grip, with sides specifically designed for easy pushing/pulling when mating/unmating
- Metric thread M40 cable gland IP68 watertight compliant with EN/CE, adapters available for cables over 32 mm diameter
- Multipoint contact area
- Silver Plated Contacts
- Mechanically keyed to prevent mating errors
- High Impact bodies
- Screw, Crimp and Lug terminals to facilitate cables from 25mm<sup>2</sup> to 300 mm<sup>2</sup>
- Permanent marking to identify phase/line and safety information embossed on connector's body

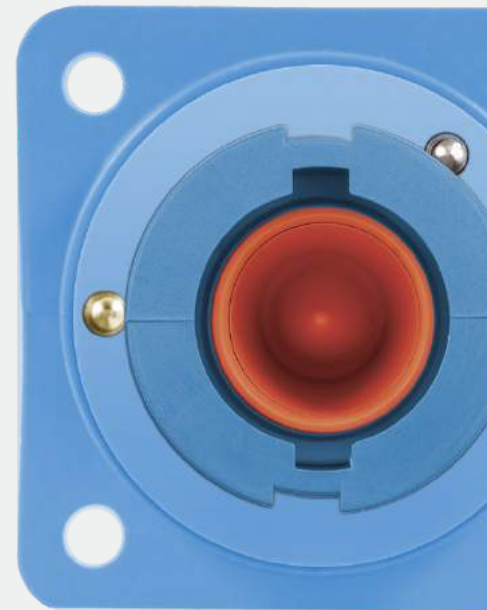

## Typical applications

- Electrical power systems
- Power distribution
- Outdoor concerts and sporting events
- Outdoor broadcasting
- Theatres
- Mobile generators
- Industrial vehicles
- Railway installations
- Military installations
- Load banks
- Backup power systems
- Electrical power supply companies
- Heavy industry

## Technical data

- **Number of contacts:** single pole
- **Max continuous current rating with brass or bimetal contact:** 480amp
- **Max continuous current rating with copper contact:** 750amp
- **Operating Voltage:** 1.000V AC / 1.500V DC
- **Test Voltage:** 4.500 V AC
- **Short Circuit Rating:** 16,1kA (1 sec) 13,8kA (2 sec) 11,5kA (3 sec) 35,5kA (peak)
- **Insulation Resistance:** >5.000 MOhm @500V
- **IP rating when mated:** IP67
- **Protection against electric shock:** IP2X
- **Contact resistance:** <0.1 mOhm
- **Housing material:** high temperature thermoplastic
- **Flammability:** UL94 V0
- **Coupling method:** bayonet lock with secondary locking pin
- **Number of mating cycles:** >500
- **Operating temperature:** -30°C/+125°C

	Ground	Neutral	Line 1	Line 2	Line 3
Europe & UK	Green	Blue	Brown	Black	Grey
UK (old)	Green	Black	Red	Yellow	Blue
Australia	Green	Black	Red	White	Blue
U.S.A.	Green	White	Black	Red	Blue

## IP2X drain contact safety lock Patented by Syntax

On our drain single pole connectors, the IP2X protection is obtained through a patented safety lock of the sharp-pointed insulated cap. This solution prevents pushing the contact inwards with fingers and provides mechanical lock in case of improper pushing of the contact.

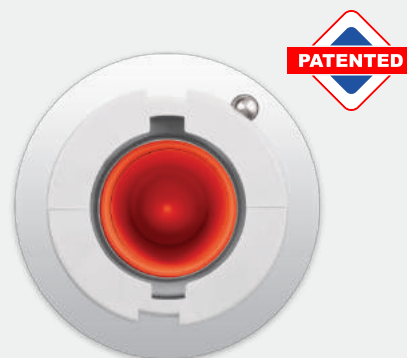

### PowerSyntax contact guide pin

For easy alignment of the holes on contact and insulating body, and quick insertion of the red dowel pin, the PowerSyntax contacts feature a guide pin with a corresponding recess in the insulator.

After locating recess **A** in the body, find guide pin **B** on the contact, then insert guide pin **B** inside recess **A**, as shown in picture **C**.

For contact fastening, after locating hole **D** on the body, insert dowel pin **E** in hole **D**. Contact retention is then completed (**F**).



### Multilouver contact band and locking mechanism

To prevent a faulty retention of the contact band (1) and to ensure the efficiency of the connection, we adopted a solution which keeps the multilouver spring loaded band in location. The contact band is held in its locked position by a special ring, on which a 2.5 ton. pressure has been applied (2). This solution prevents derailment of the multilouver contact band (3).



### Source contact IP2X threaded protection

The touch-proof protection on source contacts features a threaded attachment. A breakage of the insulation caps is a risk for the operators' safety. Thanks to this solution, the touch-proof cap is threaded and then blocked with specific adhesives. The bond between the protective elements and the live parts is strengthened, improving safety through a reduced exposure of the metal parts, as a portion of the cap will remain in position even in case of damage.



## Chain pilot

### Drain and source panel connectors with **Microswitch**

The new CHAIN PILOT system is an evolution of the PowerSyntax SPX panel-mount single pole connectors. VALENTINI - Syntax® has become the first manufacturer in the world to have developed and marketed powerlock-style panel-mount connectors with in-built microswitch (international patent). Thanks to Valentini's innovative solution, protective electrical interlocking and/or additional controls can now be obtained for the first time on powerlock-style connections through a chain of simultaneously operating connectors, allowing constant monitoring of all the conductors in a power circuit (either for source or distribution; see circuit diagrams below). When a panel connector is mated with its coupling cable connector, a spring device pressed by the thermoplastic insulated body edge of the cable connector is operated to activate the pilot microswitch housed in the rear of the flange. The SPX Chain Pilot panel mount connectors are available in drain (male) or source (female) versions, for up to 480amp or up to 750amp. They are fully intermateable with standard PowerSyntax or other powerlock-style connectors.



## Technical data

### Pilot microswitch



- Switching function: Changeover switch (spdt momentary)
- Number of poles: 1 - pole
- Connections: Quick-connect terminal, 2.8 x 0.5, sealed
- Mechanical life endurance: 10E6 Rating IEC / Rating North America 10 (3) a 250 v ac 10E3
- Design: DIN 41635 B
- Contact resistance (new condition): < 100 (1 A 12 V DC Mohm)
- Insulation resistance (new condition): > 100 (500 V DC) Mohm
- Voltage strength at 250V:
  - function insulation / basic insulation 1 500 V
  - small contact distance 500 V
- Insulation spacing: acc. to EN 61058 for reinforced or double insulation
- Flammability: UL 94 V-0
- Glow wire test temperature: 850 °C

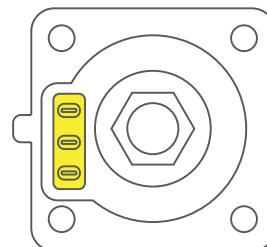
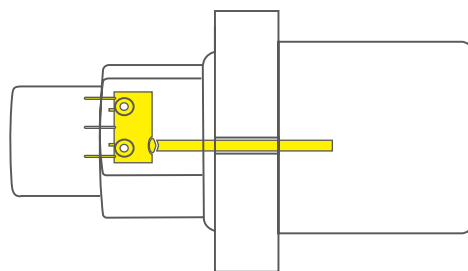

## Activation button!

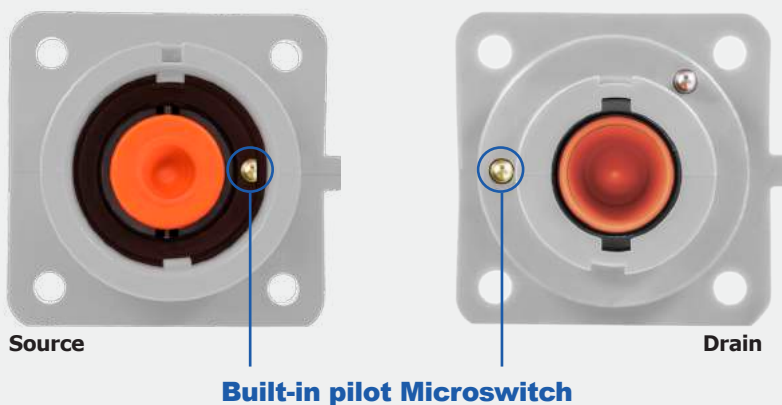

### Panel source

#### With microswitch

On the panel source, the spring device activating the microswitch is placed inside the mating part of the connector's shell.



### Panel drain

#### With microswitch

On the panel drain, the spring device activating the microswitch is placed outside the mating part of the connector's shell.

## Examples of connection applications

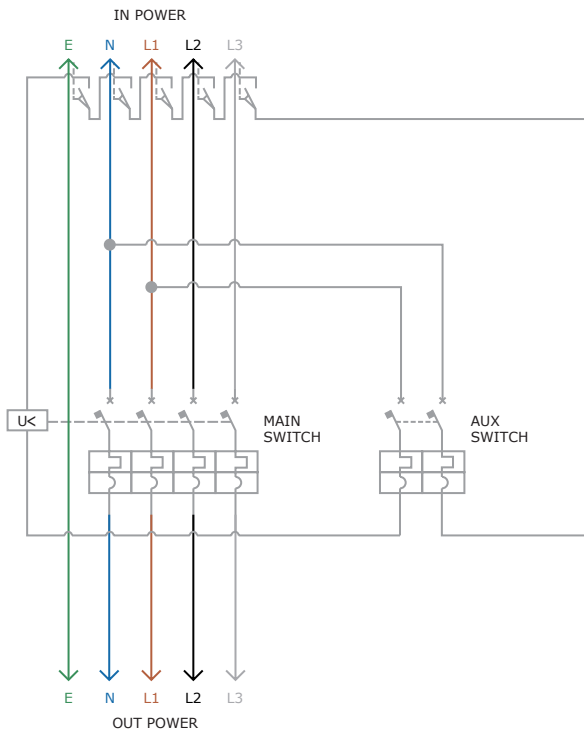

**5 Panel drain circuit**  
Example 1

5 PowerSyntax series panel drain connectors with built-in microswitches for phaseconductors "L1, L2 & L3", neutral "N" and ground "E".

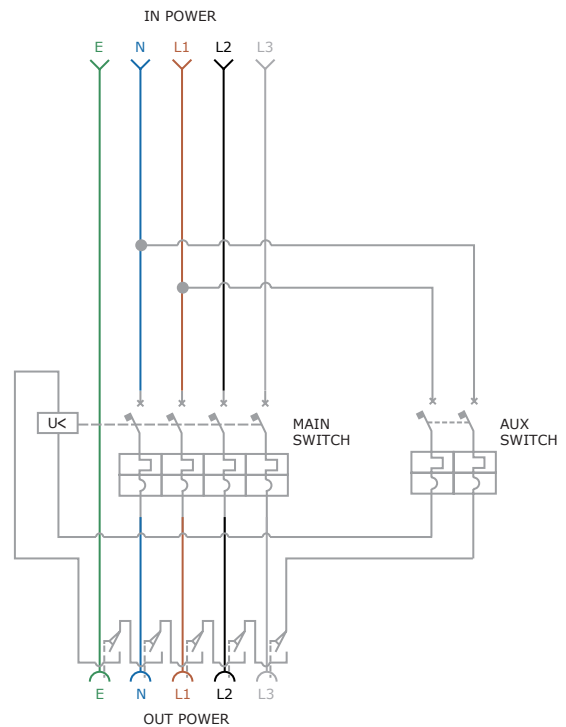

**5 Panel source circuit**  
Example 2

5 PowerSyntax series panel source connectors with built-in microswitches for phase conductors "L1, L2 & L3", neutral "N" and ground "E".

## Contacts for the Chain Pilot

The PowerSyntax Chain Pilot Panel connectors are equipped with different contact types, depending on current rating (480amp or 750amp) and cable terminations.



**M12 threaded post**  
Standard contact

Up to 480 amp or 750 amp (all-copper contact). Lug terminal retained through M12 nut. Used as a standard on SPX 4 and SPX 7 panel-mount connectors.



**M12 extended threaded post**  
Exclusive design

Up to 480 amp or 750 amp (all-copper contact). Lug terminal retained through M12 nut. Longer contact allows connectors mating without interfering with the microswitch's contacts.



**M12 threaded hole**  
Standard contact

Up to 480 amp or 750 amp (all-copper contact). Lug terminal retained through M12 bolt. Used as an alternative for M12 threaded-post contacts on SPX 4 and SPX 7 panel-mount connectors.



## Overall dimensions

### Chain pilot panel connector

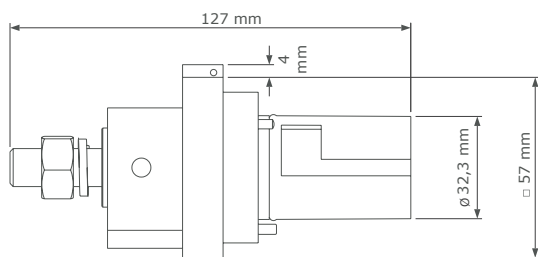

**Panel drain**  
with M12 standard threaded post

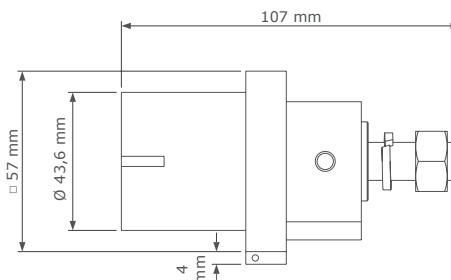

**Panel source**  
with M12 standard threaded post

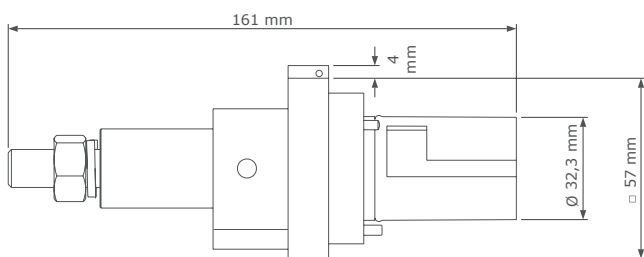

**Panel drain**  
with M12 extended threaded post

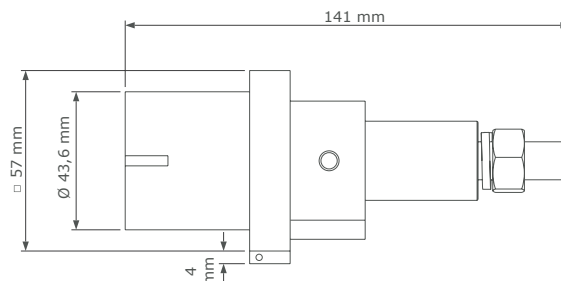

**Panel source**  
with M12 extended threaded post

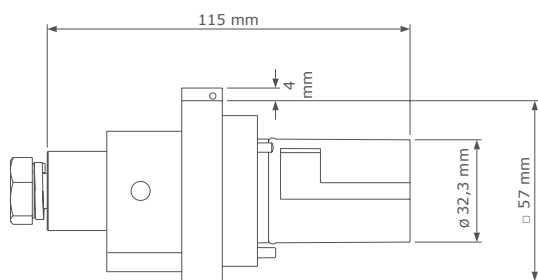

**Panel drain**  
with M12 threaded hole

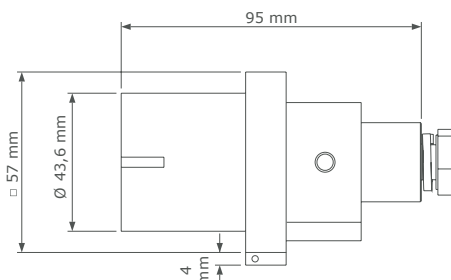

**Panel source**  
with M12 threaded hole

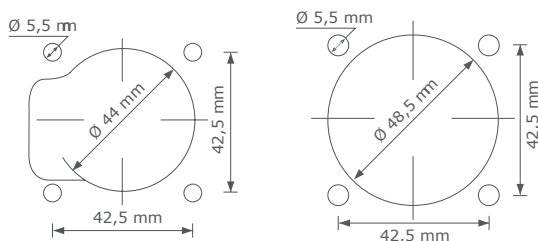

**Panel drain front/rear**

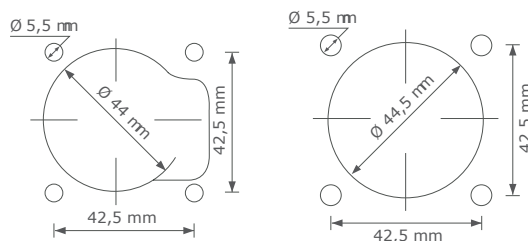

**Panel source front/rear**



## Chain Pilot Box

### The non-sequential safety box

The PowerSyntax Chain Pilot box features a set of PowerSyntax Chain Pilot connectors with L1+L2+L3+N+PE (or L1+L2+L3+PE), each one with its built-in microswitch. The connector's microswitches control an auxiliary circuit connected to an external device (breaker, contactor, etc.), so that the system will only be activated once all the mechanically keyed cable connectors have been inserted in the corresponding panel-mount connectors on the Chain Pilot Box. So there is no need to respect a sequential order when mating or unmating your connectors, unlike other Powerlock-compatible boxes.

**All connectors will de-energise should one become disconnected when in use.**



## Product overview

- Insert all the cable connectors to activate the breaker or protection device.
- All connectors will de-energise should one become disconnected when in use.
- Built-in microswitch for electrical interlock on all connectors.
- No mechanical locks / longer lifespan.
- Ensures safe connection of all phases, neutral and earth.
- Electrical safety guaranteed.
- International patent on connectors

### Supply notice

Environmental caps supplied as a standard to ensure IP67 even when connectors are unmated.

## Technical features

- Intermateable with standard PowerSyntax or other powerlock-style connectors.
- Microswitch-controlled auxiliary circuit ensures that the system will only be energised when all 5 connectors on the box have been mated.
- Total electrical safety as all connectors are de energised should one become disconnected.
- Color coded connectors.
- 5-pole (E-N-L1-L2-L3) or 4-pole (E-L1-L2-L3) system with Panel Drain or Source connectors.
- Mechanically keyed connectors to prevent mating errors.
- Secondary lock for added mechanical safety.
- IP2X finger-proof protection.
- 2U 19" rack-mountable box.
- IP67 rating on connectors' front mating side.
- Microswitch-controlled auxiliary circuit ensures that the system will only be energised when all connectors on the box have been mated.



Chain Pilot panel connectors are patented by Syntax

## Technical data

- Rated current: 480amp or 750amp
- Rated voltage: 1000V AC / 1500V DC
- Color coding:
  - EUROPE:** color coded connectors and panel inscriptions (E-green, N-blue, L1-brown, L2-black, L3-grey)
  - UK (old):** color coded connectors (E-green, N-black, L1-red, L2-yellow, L3-blue)
  - AUSTRALIA:** color coded connectors (E-green, N-black, L1-red, L2-white, L3-blue)
  - USA:** color coded connectors (E-green, N-white, L1-black, L2-red, L3-blue)
- Model: source or drain
- Contact material: silver plated copper
- Box material: high temperature thermoplastic
- Rack space: 2U or 2.5U
- Endurance: 500 + connection cycles
- Degree of protection (connectors front side): IP67 when mated of with environmental caps fitted (IP67 caps supplied as a standard)
- Degree of protection (connectors without caps): IP2X finger-proof
- Flammability: UL94 - V0
- Operating temperature: -30°C to +85°C
- Safety notice: The PowerSyntax chain pilot box should only be installed and operated by suitably qualified persons



## Possible configurations

Configure your own Chain Pilot Box choosing between a wide range of options: 4 or 5 poles, color coding by geographical region, source or drain connectors, up to 480A or up to 750A, 2U or 2,5U of box height and contact type, threaded post or threaded hole.

### 1.

#### Choose your connector style

The PowerSyntax Chain Pilot connectors are available in Panel Drain e Panel Source versions.

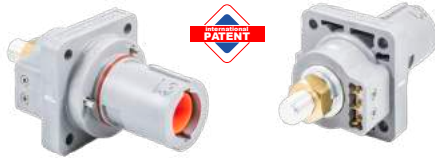

**Panel drain**  
**With microswitch**

On the panel drain, the spring device activating the microswitch is placed outside the mating part of the connector's shell.

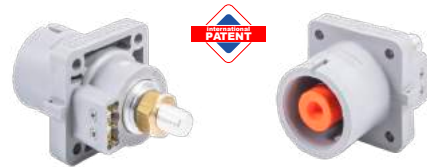

**Panel source**  
**With microswitch**

On the panel source, the spring device activating the microswitch is placed inside the mating part of the connector's shell.

### 2.

#### Choose the number of poles

The Chain Pilot Box can be ordered with the standard 5-poles (G - N - L1 - L2 - L3) or in the 4-poles (G - L1 - L2 - L3) version.



**5-poles version**



**4-poles version**

### 3.

#### Choose the color coding

The PowerSyntax Chain Pilot connectors can be coded for Europe, UK (old), Australia and U.S.A. color schemes.

##### Identification color codes (5-POLES)

	Ground	Neutral	Line 1	Line 2	Line 3
Europe & UK	Green	Blue	Brown	Black	Grey
UK (old)	Green	Black	Red	Yellow	Blue
Australia	Green	Black	Red	White	Blue
U.S.A	Green	White	Black	Red	Blue

##### Identification color codes (4-POLES)

	Ground	Line 1	Line 2	Line 3
Europe & UK	Green	Brown	Black	Grey
UK (old)	Green	Red	Yellow	Blue
Australia	Green	Red	White	Blue
U.S.A	Green	Black	Red	Blue

### 4.

#### Choose the contact's terminal

The PowerSyntax Chain Pilot Panel connectors in the Chain Pilot Box are equipped with different contact types, depending on current rating (480amp or 750amp) and cable terminations.



**M12 extended threaded post**

M12 threaded-post contact, up to 480 amp or 750 amp (all-copper contact). Lug terminal retained through M12 nut. Longer contact allows connectors mating without interfering with the microswitch's contacts.



**M12 threaded hole**

M12 threaded-hole contact, up to 480 amp or 750 amp (all-copper contact). Lug terminal retained through M12 bolt. Used as an alternative for M12 threaded-post contacts on SPX 4 and SPX 7 panel-mount connectors.

## 5.

### Choose the box height

Pick the right box for your rack, we can provide two options: 2U and 2.5U. Both choices are available for the 4-poles or the 5-poles versions.

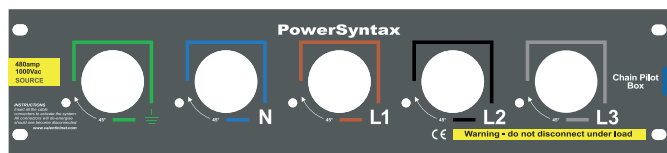

**Box height: 2U (88mm)**

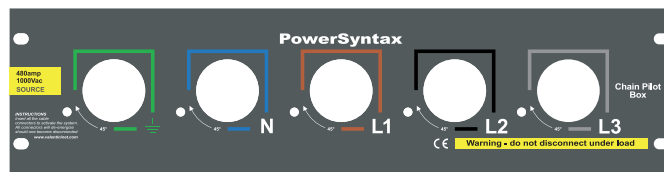

**Box height: 2.5U (108mm)**

### Overall dimensions

#### Chain pilot box

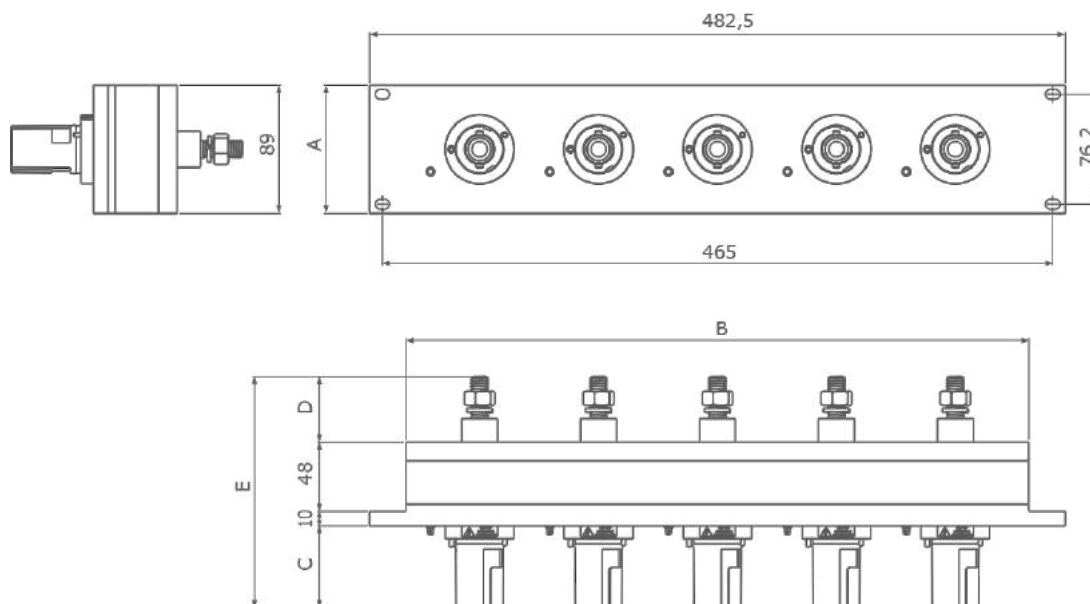

Type	Poles	Units	Contact	A	B	C	D	E
Drain	4	2U	M12 post	88 mm	349,5 mm	57 mm	46 mm	161 mm
Drain	4	2U	M12 hole	88 mm	349,5 mm	57 mm	16,3 mm	131,3 mm
Drain	4	2.5U	M12 post	108 mm	349,5 mm	57 mm	46 mm	161 mm
Drain	4	2.5U	M12 hole	108 mm	349,5 mm	57 mm	16,3 mm	131,3 mm
Drain	5	2U	M12 post	88 mm	432 mm	57 mm	46 mm	161 mm
Drain	5	2U	M12 hole	88 mm	432 mm	57 mm	46 mm	161 mm
Drain	5	2.5U	M12 post	108 mm	432 mm	57 mm	46 mm	161 mm
Drain	5	2.5U	M12 hole	108 mm	432 mm	57 mm	16,3 mm	131,3 mm
Source	4	2U	M12 post	88 mm	349,5 mm	35 mm	46 mm	139 mm
Source	4	2U	M12 hole	88 mm	349,5 mm	35 mm	16,3 mm	109,3 mm
Source	4	2.5U	M12 post	108 mm	349,5 mm	35 mm	46 mm	139 mm
Source	4	2.5U	M12 hole	108 mm	349,5 mm	35 mm	16,3 mm	109,3 mm
Source	5	2U	M12 post	88 mm	432 mm	35 mm	46 mm	139 mm
Source	5	2U	M12 hole	88 mm	432 mm	35 mm	16,3 mm	109,3 mm
Source	5	2.5U	M12 post	108 mm	432 mm	35 mm	46 mm	139 mm
Source	5	2.5U	M12 hole	108 mm	432 mm	35 mm	16,3 mm	109,3 mm

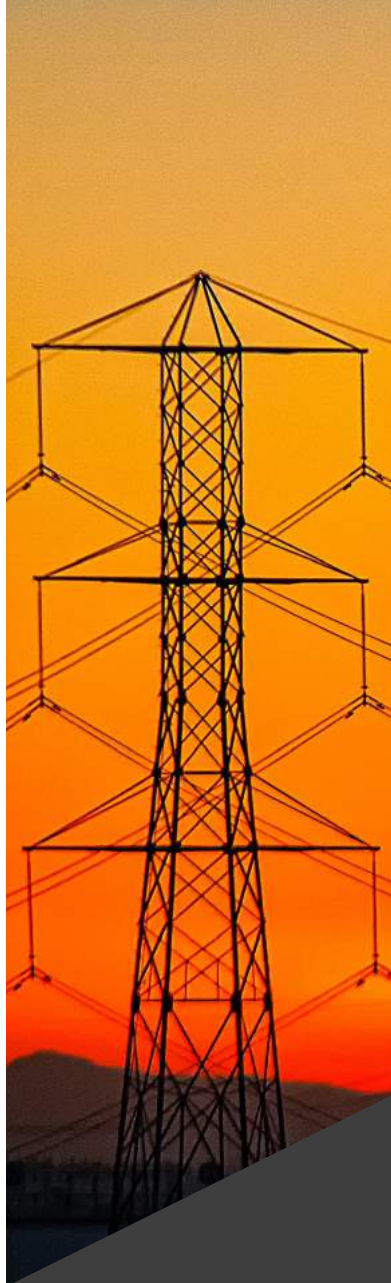

## **Basic panel or shelter**

**Panel source, panel drain,  
with threaded body and backshell**

Discover our innovative, Powerlock compatible, single pole panel connectors: 3 options that will improve your productivity while bringing you peace of mind on all electrical insulation and safety-related issues. And no compromises on connectors' design and performances.

## Basic panel connector Panel Drain or Panel Source

Specific housing for protection cap lacing moulded on the plastic body of the flange. IP2X protection through patented drain contact lock and source finger protection to prevent touching live parts. Contact to housing retention through flame-retardant UL94-VO plastic cotter pin. No special assembling tools needed. Secondary locking safety system. Front or rear panel mount. Optional M5 threaded fittings available for rear panel mount. Permanent phase / line identification and safety information markings embossed on connector's shell. No additional information stickers applied. SPX 4 480amp and SPX 7 750amp versions available. M12 contacts with M12 threaded post or M12 threaded hole. Set screw, Crimp or EasiLug contacts available or request. Threaded body with thermoplastic backshell and IP68 cable gland available. For secondary lock release, use SyntaxLock or standard release key.



## Shelter panel connector with threaded body and backshell

The PowerSyntax SPX panel mount connectors are available with threaded body to fit a thermoplastic backshell. As well as the backshell, this system features an IP68 cable gland and provides IP67 watertight seal at the cable clamp. This version can be supplied with a set-screw contact terminal with reduction sleeves for 25-150 mm<sup>2</sup> copper cables up to 480 amp



## Panel mount cut-out options Basic panel and shelter

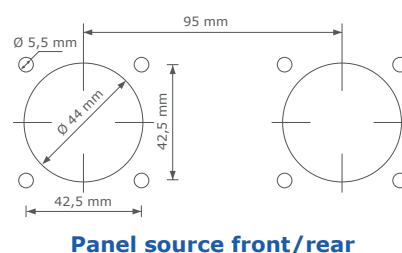
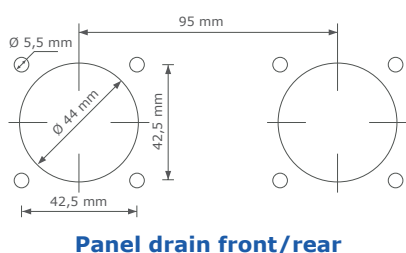

## Overall dimensions

### Basic panel and shelter

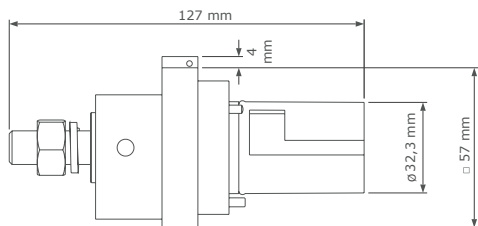

**Panel drain**  
with M12 standard threaded post

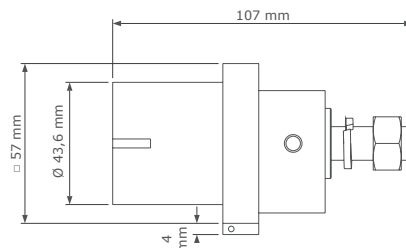

**Panel source**  
with M12 standard threaded post

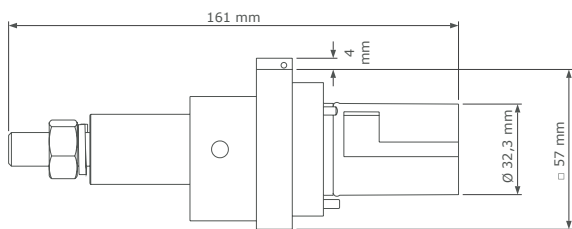

**Panel drain**  
with M12 extended threaded post

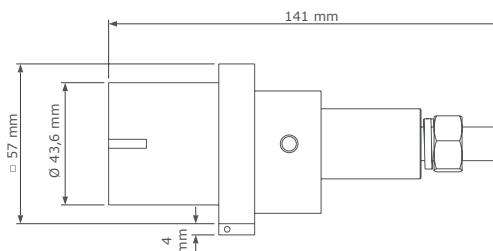

**Panel source**  
with M12 extended threaded post

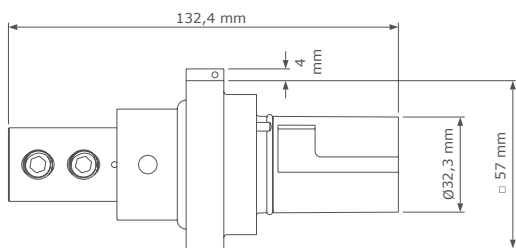

**Panel drain**  
with set screw contact

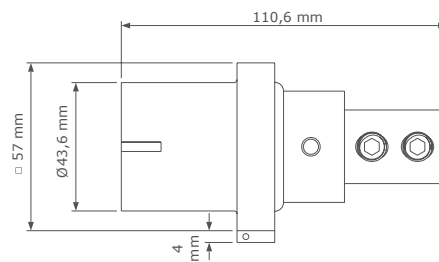

**Panel source**  
with set screw contact

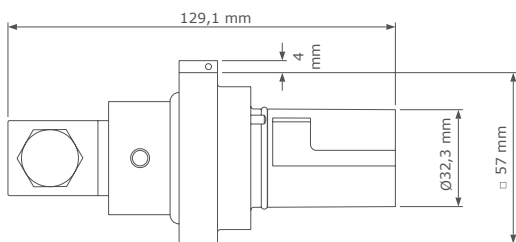

**Panel drain**  
with ComLug L

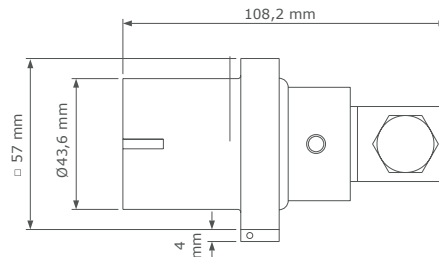

**Panel source**  
with ComLug L

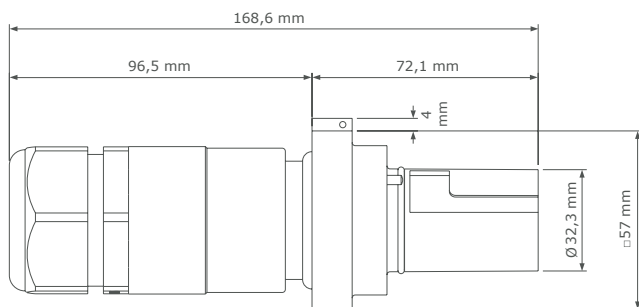

**Shelter panel drain**  
with backshell

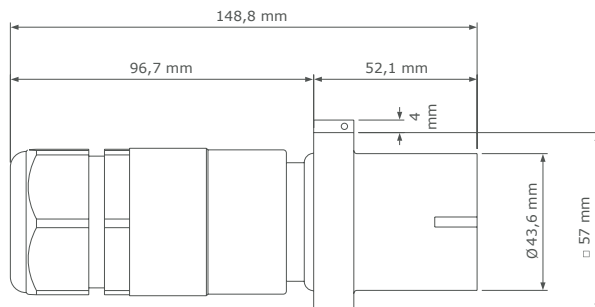

**Shelter panel source**  
with backshell



## Contacts for panel-mount connectors

The PowerSyntax Panel connectors are equipped with different contact types, depending on current rating (480amp or 750amp) and cable terminations.



### M12 threaded post for Basic panel

Up to 480 amp or 750 amp (all copper contact). Lug terminal retained through M12 nut. Used as a standard on SPX 4 and SPX 7 panel-mount connectors.



### M12 threaded hole for Basic panel

Up to 480 amp or 750 amp (all copper contact). Lug terminal retained through M12 bolt. Used as an alternative for M12 threaded-post contacts on SPX 4 and SPX 7 panel-mount connectors.



### SPY ComLug for Basic panel

Available in two different models: the first can carry up to 480 amp, the second, entirely made of copper, up to 750 amp. Depending on the model, they can be suitable for lug terminals up to 240 mm<sup>2</sup>.



### SPX SPZ set screw contact for Basic panel and shelter

Up to 480amp. Cable retained through reduction sleeve (25-150 mm<sup>2</sup>) and set screws suitable reduction sleeve is included. Used as a standard on SPX/SPZ 480amp line source/drain connectors, the set screw contact is also available for panel-mount connectors on request.

## Sleeve adapter system for set screw contacts

**The ultimate solution for 25 to 95 mm<sup>2</sup> cables.**

The PowerSyntax Sleeve Adapter is a unique mechanical solution for ideal cable retention when a PowerSyntax with set screw contact is used with cable sections of 95 mm<sup>2</sup> or smaller.

On other connectors on the market, multiple concentric sleeves are used to reduce the cable section from 150 or 120 mm<sup>2</sup> down to the smaller section specifically needed. The thoughtful design and the mechanical reliability of our sleeve adapter eliminates the need to use multiple concentric sleeves.



Cable section (class 5)	25 mm <sup>2</sup>	35 mm <sup>2</sup>	50 mm <sup>2</sup>	70 mm <sup>2</sup>	95 mm <sup>2</sup>	120 mm <sup>2</sup>	150 mm <sup>2</sup>
Recommended sleeve adapter (p/n)	SPX-RED025	SPX-RED035	SPX-RED050	SPX-RED070	SPX-RED095	-	-
Cable strip length	33 mm	33 mm	33 mm	33 mm	33 mm	33 mm	33 mm
Set screw tightening torque	12Nm	12Nm	12Nm	12Nm	12Nm	12Nm	12Nm
M10 hex set screw (2pcs)	allen key size 5	allen key size 5	allen key size 5	allen key size 5	allen key size 5	allen key size 5	allen key size 5



## Line connectors

Line source and Line drain  
480 and 750 amp

A full range of high current, Powerlock compatible, single pole connectors for your cables. With 3 different shell versions and 6 contact types, an unprecedented range of combinations is made available for you.

No matter the section of your cables, in the PowerSyntax range you are sure to find YOUR ideal solution to manage any sections from 25 to 300 mm<sup>2</sup>. For copper or aluminium cables, with no compromises on connectors' design and performances.

## Short body connector

### Line drain and line source | 480 amp

Innovative ergonomic hand grip for easy handling. IP2X protection through patented drain contact lock and source finger protection to prevent touching live parts. Contact to housing retention through flame-retardant UL94-VO plastic cotter pin. No special assembling tools needed. Secondary locking safety system. Set Screw termination for 25 mm<sup>2</sup> - 150 mm<sup>2</sup> cables. IP68 watertight m40 plastic cable gland for cable strain relief, with 15 - 32 mm clamping range. Permanent phase/line identification and safety information markings embossed on connector's shell. No additional information stickers applied.



## Standard body connector

### Line drain and line source 480 amp & 750 amp

Innovative ergonomic hand grip for easy handling. IP2X protection through patented drain contact lock and source finger protection to prevent touching live parts. Contact to housing retention through flame-retardant UL94-VO plastic cotter pin. No special assembling tools needed. Secondary locking safety system. Set Screw termination for 25 mm<sup>2</sup> - 150 mm<sup>2</sup> cables. Crimp termination for cables up to 300 mm<sup>2</sup>. IP68 plastic cable gland for cable strain relief, with 15 - 32 mm (M40) or 30 - 38 mm (M50) clamping range. Permanent phase/line identification and safety information markings embossed on connector's shell. No additional information stickers applied.

## Oversized body connector

### Line drain and line source | 750 amp

Extra large body cavity, ideal when using lug terminals for big cable sections. Improved hand grip for easy handling. IP2X protection through patented drain contact lock and source finger protection to prevent touching live parts. Contact to housing retention through flame-retardant UL94-VO plastic cotter pin. No special assembling tools needed. Secondary locking safety system. IP68 plastic cable gland for cable strain relief, with 30 - 38 mm (M50) clamping range. Permanent phase/line identification and safety information markings embossed on connector's shell. No additional information stickers applied.



## Hanger grip

These heavy duty wire mesh hangers are designed to ensure the right retention of the cable without any sliding or scraping of the external jacket. This item can be used to hang the cable so to protect it from accidental pulls when mounting.

Part No.	Cable O.D. Min.	Cable O.D. Max
<b>7ZHG1</b>	12 mm	16 mm
<b>7ZHG2</b>	16 mm	18 mm
<b>7ZHG3</b>	19 mm	21 mm



## Contacts and cable retention types for line connectors

The PowerSyntax connectors are equipped with different contact types, depending on current rating (480amp or 750amp), cable material (aluminum or copper), connectors body type (line or panel-mount) and cable terminations.

### Solutions for copper cables



#### SPX SPZ set screw contact for Basic panel and shelter

Up to 480amp. Cable retained through reduction sleeve (25-150 mm<sup>2</sup>) and set screws suitable reduction sleeve is included. Used as a standard on SPX/SPZ 480amp line source/drain connectors, the set screw contact is also available for panel-mount connectors on request.

#### Sleeve adapter system for set screw contacts

The ultimate solution for 25 to 95 mm<sup>2</sup> cables.

The PowerSyntax Sleeve Adapter is a unique mechanical solution for ideal cable retention when a PowerSyntax with set screw contact is used with cable sections of 95 mm<sup>2</sup> or smaller. On other connectors on the market, multiple concentric sleeves are used to reduce the cable section from 150 or 120 mm<sup>2</sup> down to the smaller section specifically needed. The thoughtful design and the mechanical reliability of the our sleeve adapter eliminates the need to use multiple concentric sleeves.



Cable section (class 5)	25 mm <sup>2</sup>	35 mm <sup>2</sup>	50 mm <sup>2</sup>	70 mm <sup>2</sup>	95 mm <sup>2</sup>	120 mm <sup>2</sup>	150 mm <sup>2</sup>
Recommended sleeve adapter (p/n)	SPX-RED025	SPX-RED035	SPX-RED050	SPX-RED070	SPX-RED095	-	-
Cable strip length	33 mm	33 mm	33 mm	33 mm	33 mm	33 mm	33 mm
Set screw tightening torque	12Nm	12Nm	12Nm	12Nm	12Nm	12Nm	12Nm
M10 hex set screw (2pcs)	allen key size 5	allen key size 5	allen key size 5	allen key size 5	allen key size 5	allen key size 5	allen key size 5



#### SPX crimp contact for standard body connector

Crimp contact, up to 750 amp, and up to up to 300 mm<sup>2</sup> cable sections. The position and number of cable compressions vary according to the different cable sections. Cable stripping length is 42 mm.

For all crimping data see the section starting from page 24



## Lug converters for copper cables terminated with common lugs



### SPY ComLug L Lug Converter

#### For standard body connector

Contact available in two different models: the first can carry up to 480 amp, the second, entirely made of copper, up to 750 amp. Depending on the model, they can be suitable for lug terminals up to 240 mm<sup>2</sup>.



### SPY ComLug XL Lug Converter

#### For oversized body connector

Entirely designed and produced by Syntax, contact up to 750 amp and suitable for lug terminals up to 300 mm<sup>2</sup> of cable section. To be used in combination with the oversized body.

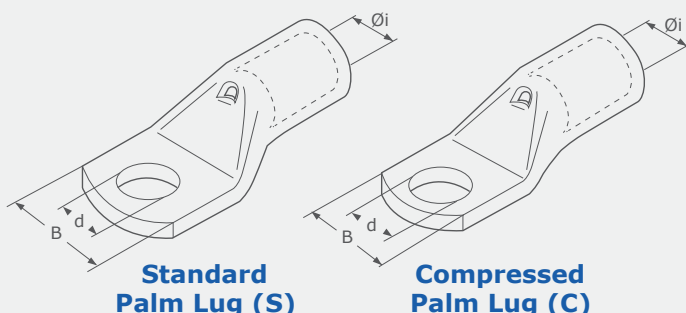

**Standard  
Palm Lug (S)**

**Compressed  
Palm Lug (C)**

Lug Type	B	Cable section (flex)	Øi	d Ø screw	Contact
S	25,0	70 - 95 mm <sup>2</sup>	13,5	12 mm	L
S	28,5	95 - 120 mm <sup>2</sup>	15,2	12 mm	L
S	31,5	120 - 150 mm <sup>2</sup>	16,7	12 mm	L
S	35,5	150 - 185 mm <sup>2</sup>	19,2	12 mm	XL
C	31,0	240 mm <sup>2</sup>	21,1	12 mm	XL
C	31,0	300 mm <sup>2</sup>	23,7	12 mm	XL

## Contacts for aluminium cables 480 amp



### SPY EasiLug - Bimetal

Complete EasiLug contact with bi-metal (aluminium/copper terminal) for aluminium cable. Used as a standard on SPY EasiLug connectors for aluminium cables, this contact type is also available for panel-mount connectors on request.

For all crimping data see the section starting from page 24



### SPV - Bimetal

Bimetal (aluminium/copper) crimp contact for up to 300 mm<sup>2</sup> cable sections. Designed to be used in combination with aluminium cables.

For all crimping data see the section starting from page 24

## Crimping data and cable stripping

On crimp contacts (up to 750amp copper / 480amp bimetal, and up to up to 300 mm<sup>2</sup> cable sections), the position and number of cable compressions vary according to the different cable sections (see tables below).

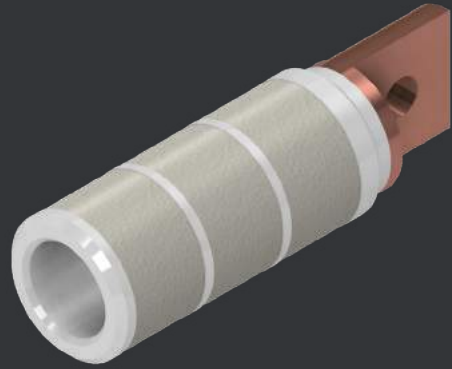

### Aluminium cables - SPY EasiLug Class 5

Lug model	120 mm <sup>2</sup>	150 mm <sup>2</sup>	185 mm <sup>2</sup>	240 mm <sup>2</sup>	300 mm <sup>2</sup>
Contact internal Ø	15 mm	16,5 mm	18,5 mm	21,3 mm	23,3 mm
Cable strip length (L)	60 mm	60 mm	60 mm	60 mm	60 mm
No. of crimpings	3	3	3	3	3
Crimping width	14 mm	14 mm	14 mm	14 mm	14 mm
Crimp die set p/n	SBH-CRIMP-120AL	SBH-CRIMP-150AL	SBH-CRIMP-185AL	SBH-CRIMP-240AL	SBH-CRIMP-300AL

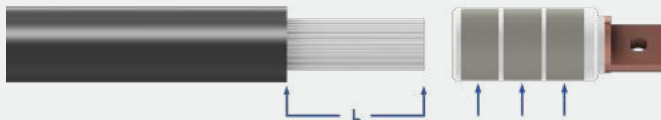

**Crimp in the middle of each crimping area, inside the guides.**

### Aluminium cables - SPV Class 5

Lug model	120 mm <sup>2</sup>	150 mm <sup>2</sup>	185 mm <sup>2</sup>	240 mm <sup>2</sup>	300 mm <sup>2</sup>
Contact internal Ø	15 mm	16,5 mm	18,5 mm	21,3 mm	23,3 mm
Cable strip length (L)	42 mm	42 mm	42 mm	42 mm	42 mm
No. of crimpings	2	2	2	2	2
Crimping width	14 mm	14 mm	14 mm	14 mm	14 mm
Crimp die set p/n	SBH-CRIMP-120AL	SBH-CRIMP-150AL	SBH-CRIMP-185AL	SBH-CRIMP-240AL	SBH-CRIMP-300AL



**Crimp in the middle of each crimping area, inside the guides.**

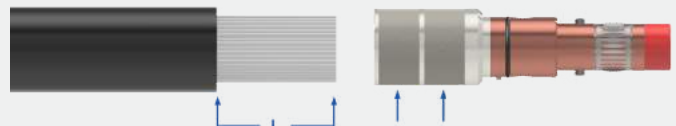

## Copper cables - SPX

### Class 5

Contact model source/drain	150 mm <sup>2</sup>	185/240 mm <sup>2</sup>	240/300 mm <sup>2</sup>	300 mm <sup>2</sup>
Contact internal Ø	17,9 mm	19,7 mm	22,2 mm	23,7 mm
Cable strip length (L)	42 mm	42 mm	42 mm	42 mm
No. of crimpings	2	2	2	2
Crimping width	14 mm	14 mm	7 mm	7 mm
Crimp die set p/n	SBH-CRIMP-185/240RM	SBH-CRIMP-185/240RM	SBH-CRIMP-240/300RM	SBH-CRIMP-240/300RM

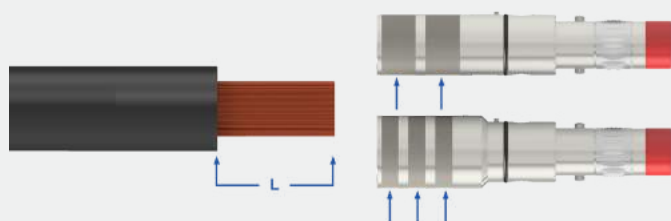

**Crimp in the middle of each crimping area, inside the guides.**

## Hydraulic crimp tool

Hand operated and cordless



**Hand operated hydraulic crimp tool**

Part No. **SBH-CRIMP-B**



**Cordless hydraulic crimp tool**

Part No. **SBH-CRIMP-C**



300 mm<sup>2</sup>

240 mm<sup>2</sup>

185 mm<sup>2</sup>



150 mm<sup>2</sup>

120 mm<sup>2</sup>

### Aluminium

**Crimp die set for hydraulic crimp tools**



185/240 mm<sup>2</sup>

240/300 mm<sup>2</sup>

### Copper

**Crimp die set for hydraulic crimp tools**

## Overall dimensions

### Line version



**Short body**

Line drain | Actual product

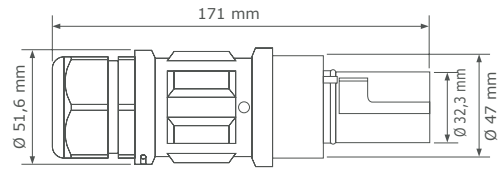

**Short body**

Line drain | Dimensions



**Short body**

Line source | Actual product

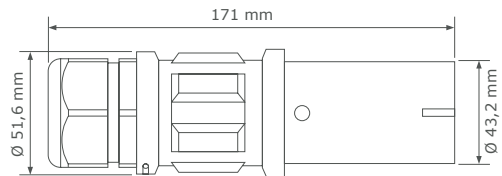

**Short body**

Line source | Dimensions



**Standard body**

Line drain | Actual product

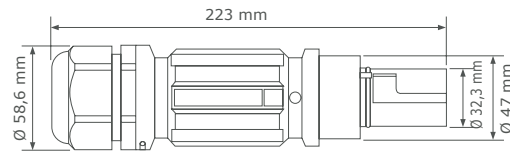

**Standard body**

Line source | Dimensions



**Standard body**

Line source | Actual product

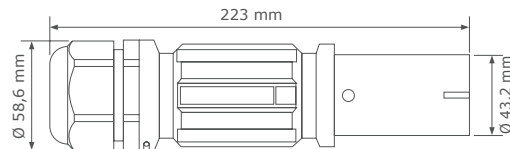

**Standard body**

Line drain | Dimensions



**Oversized body**

Line drain | Actual product

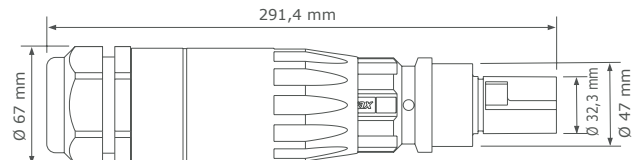

**Oversized body**

Line source | Dimensions



**Oversized body**

Line source | Actual product

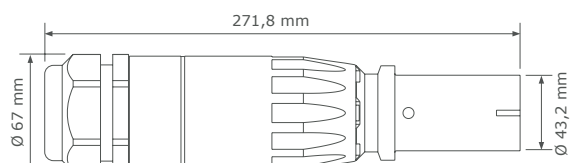

**Oversized body**

Line drain | Dimensions



# Phase Inverters / Adaptors

Fast, safe and reliable reversal of two phase conductors.

Discover the whole range of products, available for currents up to 480 or 750 amp and in every combination of phases and colors.



The PowerSyntax® Phase Inverters/Adaptors, available for electric currents up to 480 amp and now also up to 750 amp, have been designed to solve two specific problems: reverse the rotation direction in three-phase motors, etc... by changing the phase sequence (L1-L2-L3) between the power source and the connected devices; provide those who use only one model of phase conductor (L1, L2 or L3) to operate L1-L2-L3+Neutral systems with an interface between standard 3-phase power generators and distros and their devices. The former is a common demand in industrial applications. The latter is a specific need of entertainment and cinema industries.



## 480 amp available version and p/n

IN male	EU	UK	AU	US	OUT female	EU	UK	AU	US	Part Number
L1	■	■	■	■	L2	■	■	■	■	SPZ4LD1__ - LS2__
L1	■	■	■	■	L3	■	■	■	■	SPZ4LD1__ - LS3__
L2	■	■	■	■	L1	■	■	■	■	SPZ4LD2__ - LS1__
L2	■	■	■	■	L3	■	■	■	■	SPZ4LD2__ - LS3__
L3	■	■	■	■	L1	■	■	■	■	SPZ4LD3__ - LS1__
L3	■	■	■	■	L2	■	■	■	■	SPZ4LD3__ - LS2__



L3 - L2



L3 - L1



L2 - L3

## 750 amp available version and p/n

IN male	EU	UK	AU	US	OUT female	EU	UK	AU	US	Part Number
L1	■	■	■	■	L2	■	■	■	■	SPZ7LD1__ - LS2__
L1	■	■	■	■	L3	■	■	■	■	SPZ7LD1__ - LS3__
L2	■	■	■	■	L1	■	■	■	■	SPZ7LD2__ - LS1__
L2	■	■	■	■	L3	■	■	■	■	SPZ7LD2__ - LS3__
L3	■	■	■	■	L1	■	■	■	■	SPZ7LD3__ - LS1__
L3	■	■	■	■	L2	■	■	■	■	SPZ7LD3__ - LS2__



L2 - L1



L1 - L3



L1 - L2



## **S2W 480amp PowerSyntax** Multiplier | Adaptor | Phase inverter

**Available with EU, UK, AUS and USA color coding.**

A complete range of PowerSyntax multipliers, adaptors and phase inverters for currents up to 480 amp, available in standard or reverse versions and with EU, UK, AUS, and USA color coding options.



## S2W 480amp PowerSyntax multiplier

S2W with 1 drain | 2 source Syntax® PowerSyntax 480amp connectors. Available with EU, UK, AUS and USA color coding. Standard and reverse versions are available. The reverse version differs from the standard only for the position where the input connector is assembled (on the reverse version, the input is inline with one of the outputs).

### Example p/n - EU color coding

1 input male	color	2 output female	color	Part Number
Line 1		Line 1		S2WX111000S
Line 2		Line 2		S2WX222000S
Line 3		Line 3		S2WX333000S
Neutral		Neutral		S2WXNNN000S
Ground		Ground		S2WXGGG000S

#### Notice:

- for the reverse version replace final "S" by "R" in the Part Number
- for the version with safety lacing add "-L" at the end of the Part Number
- IP67 or IP53 protection caps available on request.

## Typical applications

- All temporary electrical systems
- Power distribution
- Outdoor concerts and sports events
- Outdoor broadcasting
- Theaters, studios and film sets
- Mobile generators
- Industrial vehicles
- Railway and military installations
- Load banks
- Back-up power systems

## S2W 480amp PowerSyntax phase inverters/adaptors

The PowerSyntax Phase Inverters/Adaptors (up to 480A have been designed to solve two specific problems:

- reverse the rotation direction in 3-phase motors, etc. by changing the phase sequence (L1-L2-L3) between the power source and the connected devices;
- provide those who use only one model of phase conductor (L1, L2 or L3) to operate L1-L2-L3+Neutral systems with an interface between standard three-phase power generators/distros and their devices.

The former is a common demand in industrial applications. The latter is a specific need of entertainment and cinema industries. Standard and reverse versions are available (standard versions in the photo). The reverse version differs from the standard only for the position where the input connector is assembled (on the reverse version, the INPUT is inline with one of the outputs).

### Available versions and p/n

1 input male	color	2 output female	color	Part Number
Line 1		Line 3		S2WX133000S
Line 2		Line 3		S2WX233000S
Line 3		Line 2		S2WX322000S
Line 1		Line 2		S2WX122000S
Line 2		Line 1		S2WX211000S
Line 3		Line 1		S2WX311000S

#### Notice:

- for the reverse version replace final "S" by "R" in the Part Number
- for the version with safety lacing add "-L" at the end of the Part Number
- IP67 or IP53 protection caps available on request.





Sy

## **Cable protection and management**

### **Wire mesh strain reliefs, hanger grips and pulling grips**

Explore our full range of wire mesh cable management solutions for our Syntax connectors, designed to ease optimal cable laying and organization and to provide protection from excessive bending due to gravity or any unwanted external force, in order to sensibly increase the life span of your connections.

## For a perfect connection you'll need more than a great connector

### Discover our cable management solutions

The quality of a connection depends on many factors. There's the connector, of course, and the cables are a top priority too. Not just in terms of production quality and the materials involved, but also in many aspects of the job that must not be overlooked. How you lay a cable, how you protect it from unwanted stresses, how you make sure it will be safe from external elements over time, these decisions are all integral to the achievement of a reliable connection.

That's why we offer you quality accessories thoughtfully designed and manufactured for all your cable management, handling and protection needs.

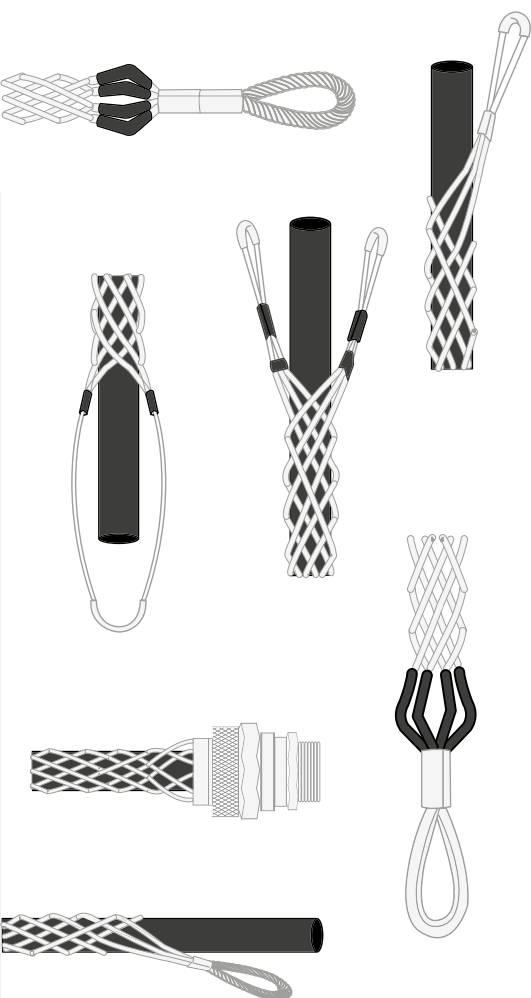

#### Strain Reliefs

Thoughtfully designed to reduce tension on cables and, therefore, stress related damages to your connections due to excessive bending. Available in a wide range of thread sizes and overall diameters to fit any connector and cable combination.

#### Hanger grips

Heavy duty wire mesh hangers are designed to ensure optimal support and right retention of the cable without any sliding or scraping of the external jacket. Different styles and sizes are available in stock for any kind of application, both indoors or outdoors.

#### Pulling grips

Created to provide the operators an efficient way to pull cables through ducts or other spaces in the safest possible way. Made to be extremely resistant and conveniently reusable, and fit to a large number of applications. Different models available.

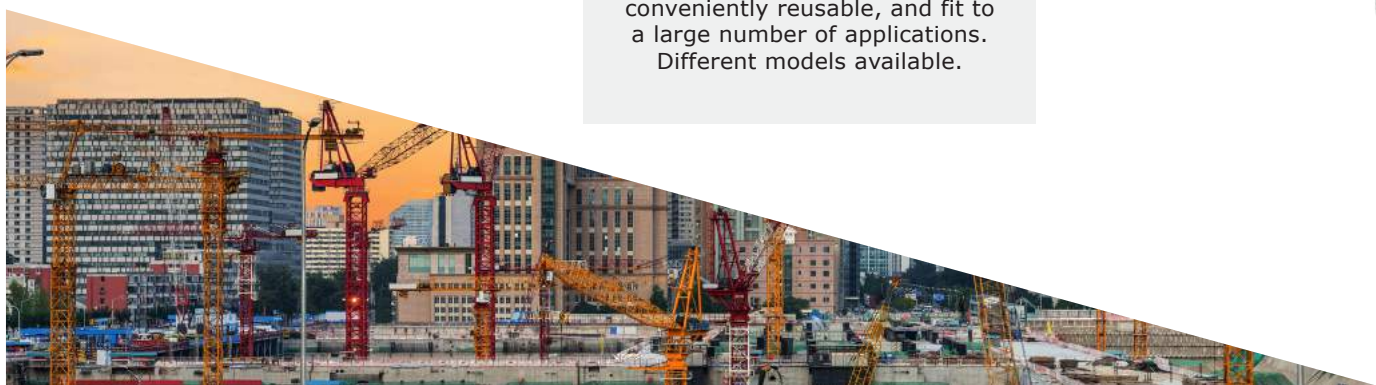
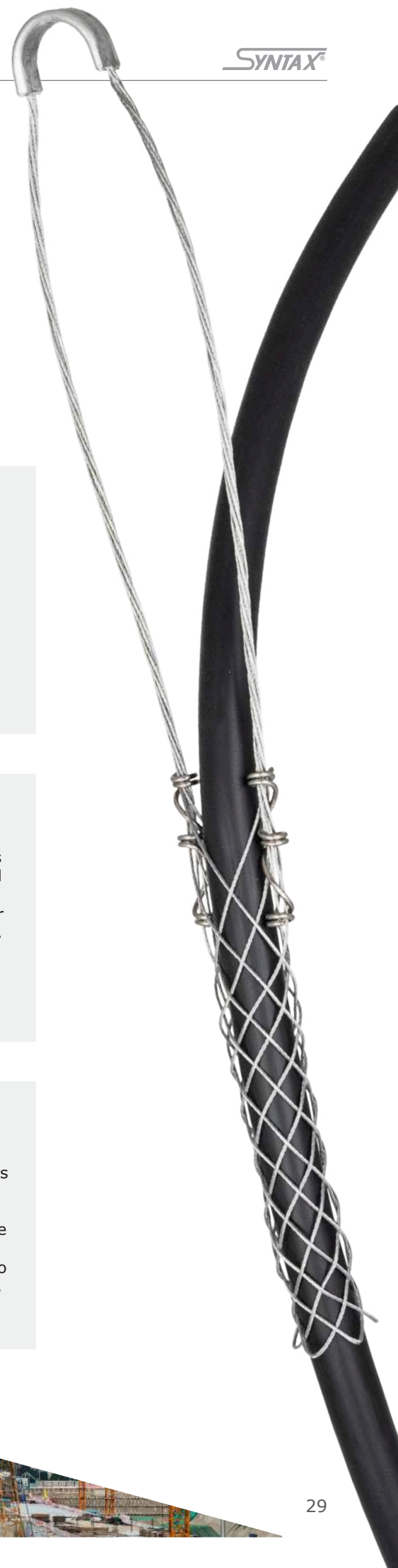

# SyntaxLock



## Release system

Suitable for all PowerSyntax connectors.  
 Can be fitted or removed at any time.  
 A simple, universal accessory.  
 Quick and easy to install



SyntaxLock is a proprietary release system for the secondary lock on PowerSyntax connectors and IP67 protection caps. It is very easy to install and to use but, in full compliance with the international electrical regulations, unmating still needs a voluntary operation on the key. SyntaxLock is supplied as a separate accessory and can be used for the retrofit of all PowerSyntax connectors built as of 2011.

## A kit for every need

The SyntaxLock is supplied as a universal kit to be fitted on line source or panel source connectors and on IP67 protection caps for drain line and panel connectors. The kit consists of a universal collar, one release key for a panel source connector, one release key for either a line source connector or a IP67 protection cap for drain connectors, one nut and bolt set.



**Panel**  
**SyntaxLock**  
 for panel source



**Line**  
**SyntaxLock**  
 for line source



**Caps**  
**SyntaxLock**  
 with IP67 protection caps



# Protection caps

## IP67 and IP53

The PowerSyntax IP67 caps ensure complete waterproof protection and IP53 caps are a fast, easy way to protect connectors.

### IP67 Protection caps

The PowerSyntax IP67 caps ensure complete waterproof protection

The PowerSyntax caps are universally keyed to be fitted on any connector's phase, so that just one cap version is needed respectively for Source and Drain connectors resulting in easier management and lower investment through reduced stock assortment. For full safety, the PowerSyntax IP67 caps feature the secondary locking system. The secondary lock will be released using SyntaxLock or a standard release key.



**IP67 protective cover for source**  
with special housing on caps for lacing



**IP67 protective cover for drain**  
with special housing on caps for lacing



### Protection caps lacing

On the PowerSyntax caps, all details have been designed with a strong focus on resistance and reliability. A specific housing for the cap's lacing has been moulded directly on the flange of the panel-mount versions and on the body of the inline versions. The caps are laced to the connector's body through a special high-resistance cable made up of seven stainless strands, and covered by anti-scratch teflon black tubing.

### IP53 Protection caps

The IP53 caps are fast, easy way to protect PowerSyntax connectors

- The use of protective caps results in:
- Extended life span of the connectors as the mating faces are protected against impact damage and abrasion.
  - Improved safety as contacts are protected against dust and water even when the connectors are not mated.



**IP53 protective cover for source**  
with special housing on caps for lacing



**IP53 protective cover for drain**  
with special housing on caps for lacing

## PART NUMBER EXPLANATION

PowerSyntax Line connectors version short and standard

Example Part Number

**SPX** **4** **LD** **E** **GN** **025** **MQ**



### Connector Series

**SPX** Standard body  
**SPZ** Short body

### Maximum Current Rating

**4** Up to 480amp (25 to 150mm<sup>2</sup>)  
**7** Up to 750amp (185 to 300mm<sup>2</sup>)  
 - Crimp contact also available from 25 to 150mm<sup>2</sup> on request

### Connector Style

**LD** Line Drain  
**LS** Line Source

### Key Composition

**E** Earth  
**N** Neutral  
**1** Phase 1  
**2** Phase 2  
**3** Phase 3

### Insulator Color

**GN** Green   
**BL** Blue   
**BR** Brown   
**BK** Black   
**GY** Gray   
**RD** Red   
**YE** Yellow   
**WH** White

### Contact Versions

#### Set-screw contact

**025** 25 mm<sup>2</sup>  
**035** 35 mm<sup>2</sup>  
**050** 50 mm<sup>2</sup>  
**070** 70 mm<sup>2</sup>  
**095** 95 mm<sup>2</sup>  
**120** 120 mm<sup>2</sup>  
**150** 150 mm<sup>2</sup>

#### Crimp contact (only SPX series)

**179** 150/185 mm<sup>2</sup> | internal Ø 17,9 mm | No. of crimpings 2  
**197** 185/240 mm<sup>2</sup> | internal Ø 19,7 mm | No. of crimpings 2  
**222** 240/300 mm<sup>2</sup> | internal Ø 22,2 mm | No. of crimpings 3  
**237** 300 mm<sup>2</sup> | internal Ø 23,7 mm | No. of crimpings 3

### Cable Gland

**MQ** Reduced M40 gland Ø 15-23 mm  
**MP** Normal M40 gland Ø 19-28 mm  
**MR** Oversized M40 gland Ø 22-32 mm  
**MU** M50 gland Ø 30-38 mm

### Special Versions

#### Compatible accessories to be ordered separately

**SPX-SYLOCK** SyntaxLock quick secondary lock release system  
**SPXTKEY** Secondary lock release key

**SPXDSC-SC** IP53 Protective plastic cap kit for source connectors  
**SPXDSD-SC** IP53 Protective plastic cap kit for drain connectors  
**SPXDSC-SC-IP67** IP67 protection cap for source connectors  
**SPXDSD-SC-IP67** IP67 protection cap for drain connectors

**SPX-RED025** Sleeve adapter for 25mm<sup>2</sup> set-screw contact  
**SPX-RED035** Sleeve adapter for 35mm<sup>2</sup> set-screw contact  
**SPX-RED050** Sleeve adapter for 50mm<sup>2</sup> set-screw contact  
**SPX-RED070** Sleeve adapter for 70mm<sup>2</sup> set-screw contact  
**SPX-RED095** Sleeve adapter for 95mm<sup>2</sup> set-screw contact



## PART NUMBER EXPLANATION

PowerSyntax panel connectors

Example Part Number

**SPX 4 PD E GN 150 MQ T5**

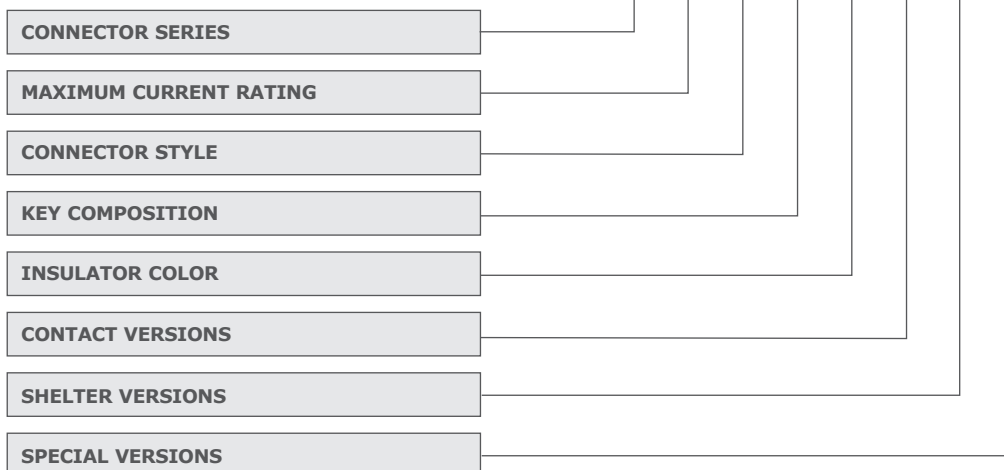

### Connector Series

**SPX** Standard version

### Maximum Current Rating

**4** Up to 480amp (25 to 150mm<sup>2</sup>)  
**7** Up to 750amp (185 to 300mm<sup>2</sup>)

### Connector Style

**PD** Panel Drain  
**PS** Panel Source

### Key Composition

**E** Earth  
**N** Neutral  
**1** Phase 1  
**2** Phase 2  
**3** Phase 3

### Insulator Color

**GN** Green   
**BL** Blue   
**BR** Brown   
**BK** Black   
**GY** Gray   
**RD** Red   
**YE** Yellow   
**WH** White 

### Contact Versions

**M02** Threaded M12 hole  
**M12** Threaded M12 post

### Set-screw contact

**025** 25 mm<sup>2</sup>  
**035** 35 mm<sup>2</sup>  
**050** 50 mm<sup>2</sup>  
**070** 70 mm<sup>2</sup>  
**095** 95 mm<sup>2</sup>  
**120** 120 mm<sup>2</sup>  
**150** 150 mm<sup>2</sup>

### Crimp contact (only SPX series)

**179** 150/185 mm<sup>2</sup> | internal Ø 17,9 mm | No. of crimpings 2  
**197** 185/240 mm<sup>2</sup> | internal Ø 19,7 mm | No. of crimpings 2  
**222** 240/300 mm<sup>2</sup> | internal Ø 22,2 mm | No. of crimpings 3  
**237** 300 mm<sup>2</sup> | internal Ø 23,7 mm | No. of crimpings 3

### SHELTER Special Versions with backshell

**00** Connector body without backshell thread  
**M0** Backshell without cable gland  
**MQ** Threaded body with backshell and reduced M40 gland Ø 15-23 mm  
**MP** Threaded body with backshell and normal M40 gland Ø 19-28 mm  
**MR** Threaded body with backshell and oversized M40 gland Ø 22-32 mm  
**MU** Threaded body with backshell, M40-M50 adaptor M50 gland Ø 30-38 mm (please contact us for more information about the sizes)

### Special Versions

**00** No special version  
**T5** Brass M5 threaded inserts (4 inserts applied to the connector)  
**NF** No flange

### Compatible accessories to be ordered separately

**SPX-SYLOCK** SyntaxLock quick secondary lock release system  
**SPXTKEY** Secondary lock release key

**SPXDSCS-SC** IP53 Protective plastic cap kit for source connectors  
**SPXDSCD-SC** IP53 Protective plastic cap kit for drain connectors  
**SPXDSCS-SC-IP67** IP67 protection cap for source connectors  
**SPXDSCD-SC-IP67** IP67 protection cap for drain connectors

**SPX-RED025** Sleeve adapter for 25mm<sup>2</sup> set-screw contact  
**SPX-RED035** Sleeve adapter for 35mm<sup>2</sup> set-screw contact  
**SPX-RED050** Sleeve adapter for 50mm<sup>2</sup> set-screw contact  
**SPX-RED070** Sleeve adapter for 70mm<sup>2</sup> set-screw contact  
**SPX-RED095** Sleeve adapter for 95mm<sup>2</sup> set-screw contact

## PART NUMBER EXPLANATION

PowerSyntax Chain Pilot connectors with microswitch



Example Part Number

SCP 4 PD E GN 150 00T5



### Connector Series

**SCP** Chain Pilot version

### Maximum Current Rating

**4** Up to 480amp (25 to 150mm<sup>2</sup>)  
**7** Up to 750amp (185 to 300mm<sup>2</sup>)





### Connector Style

**PD** Panel Drain  
**PS** Panel Source

### Key Composition

**E** Earth  
**N** Neutral  
**1** Phase 1  
**2** Phase 2  
**3** Phase 3

### Insulator Color

**GN** Green   
**BL** Blue   
**BR** Brown   
**BK** Black   
**GY** Gray   
**RD** Red   
**YE** Yellow   
**WH** White 

### Contact Versions

**M02** Threaded M12 hole  
**M12** Threaded M12 post  
**M22** Extended threaded M12 hole  
**M32** Extended threaded M12 post  
**025** 25 mm<sup>2</sup> Set-screw contact  
**035** 35 mm<sup>2</sup> Set-screw contact  
**050** 50 mm<sup>2</sup> Set-screw contact  
**070** 70 mm<sup>2</sup> Set-screw contact  
**095** 95 mm<sup>2</sup> Set-screw contact  
**120** 120 mm<sup>2</sup> Set-screw contact  
**150** 150 mm<sup>2</sup> Set-screw contact

### Crimp contact (only SPX series)

**179** 150/185 mm<sup>2</sup> | internal Ø 17,9 mm | No. of crimpings 2  
**197** 185/240 mm<sup>2</sup> | internal Ø 19,7 mm | No. of crimpings 2  
**222** 240/300 mm<sup>2</sup> | internal Ø 22,2 mm | No. of crimpings 3  
**237** 300 mm<sup>2</sup> | internal Ø 23,7 mm | No. of crimpings 3

### Special Versions

**00T5** Brass M5 threaded inserts  
 (4 inserts applied to the connector)

### Compatible accessories to be ordered separately

**SPX-SYLOCK** SyntaxLock quick secondary lock release system  
**SPXTKEY** Secondary lock release key

**SPXDCS-SC** IP53 Protective plastic cap kit for source connectors  
**SPXD-SC** IP53 Protective plastic cap kit for drain connectors  
**SPXDCS-SC-IP67** IP67 protection cap for source connectors  
**SPXD-SC-IP67** IP67 protection cap for drain connectors

**SPX-RED025** Sleeve adapter for 25mm<sup>2</sup> set-screw contact  
**SPX-RED035** Sleeve adapter for 35mm<sup>2</sup> set-screw contact  
**SPX-RED050** Sleeve adapter for 50mm<sup>2</sup> set-screw contact  
**SPX-RED070** Sleeve adapter for 70mm<sup>2</sup> set-screw contact  
**SPX-RED095** Sleeve adapter for 95mm<sup>2</sup> set-screw contact

## PART NUMBER EXPLANATION

### Chain Pilot Box



Patented **Chain Pilot** connectors with microswitches are employed in our Chain Pilot Box

Example Part Number

**SPB 4 D 04 EU D H S**



#### Series

**SPB** Chain Pilot box version

#### Maximum Current Rating

**4** 480amp  
**7** 750amp

#### Inside Connectors Style

**D** Drain  
**S** Source

#### Poles compositions

**04** L1 - L2 - L3 - PE  
**05** L1 - L2 - L3 - N - PE  
**22** Pos - Neg / Pos - Neg

#### Insulator Colors

**EU** Europe  
**AU** Australia  
**UK** United Kingdom  
**US** United States  
**DC** Two Batteries unit (Red - Black / Red - Black)

#### Included accessories

**D** IP67 Protection caps

#### Contact Versions

**H** Threaded M12 hole  
**P** Threaded M12 post

#### Box Height

**S** 2 units  
**F** 2,5 units

#### Compatible accessories to be ordered separately

**SPX-SYLOCK** SyntaxLock quick secondary lock release system

#### Spare parts

**SPXDCS-SC-IP67** IP67 protection cap for source connectors  
**SPXD-SC-IP67** IP67 protection cap for drain connectors  
**SPXTKEY** Secondary lock release key

## PART NUMBER EXPLANATION

Lug Converters with SPY ComLug and EasiLug contacts - Line version

Example Part Number

**SPY** **4** **LD** **E** **GN** **1L** **120** **MQ**



### Connector Series

**SPY** for Lug Series

### Maximum Current Rating

**4** Up to 480amp (25 to 150mm<sup>2</sup>)

**7** Up to 750amp (185 to 300mm<sup>2</sup>)

### Connector Style

**LD** Line Drain

**LS** Line Source

### Key Composition

**E** Earth

**N** Neutral

**1** Phase 1

**2** Phase 2

**3** Phase 3

### Insulator Color

**GN** Green

**BL** Blue

**BR** Brown

**BK** Black

**GY** Gray

**RD** Red

**YE** Yellow

**WH** White

### Lug contact type and body

**0L** EasiLug without lug terminal (standard body)

**1L** EasiLug with lug terminal (standard body)

**8L** ComLug L Threaded M12 (standard body)

**9L** ComLug XL Threaded M12 (oversized body)

### Cable Conductor size for EasiLug terminal

**000** Without EasiLug terminal / For ComLug L or XL

**120** 120 mm<sup>2</sup> aluminum cable

**150** 150 mm<sup>2</sup> aluminum cable

**185** 185 mm<sup>2</sup> aluminum cable

**240** 240 mm<sup>2</sup> aluminum cable

**300** 300 mm<sup>2</sup> aluminium cable

### Cable Gland

**MO** NO cable gland

**MQ** Reduced M40 gland Ø 15-23 mm

**MP** Normal M40 gland Ø 19-28 mm

**MR** Oversized M40 gland Ø 22-32 mm

**MU** M50 gland Ø 30-38 mm

### Special versions

**00** No special version

### Compatible accessories, to be ordered separately

**SPX-SYLOCK** SyntaxLock quick secondary lock release system

**SPXTKEY** Secondary lock release key

**SPXDSCS-SC** IP53 Protective plastic cap kit for source connectors

**SPXDSD-SC** IP53 Protective plastic cap kit for drain connectors

**SPXDSCS-IP67** IP67 protection cap for source connectors

**SPXDSD-SC-IP67** IP67 protection cap for drain connectors

## PART NUMBER EXPLANATION

Lug Converters with SPY ComLug and EasiLug contacts - Panel version

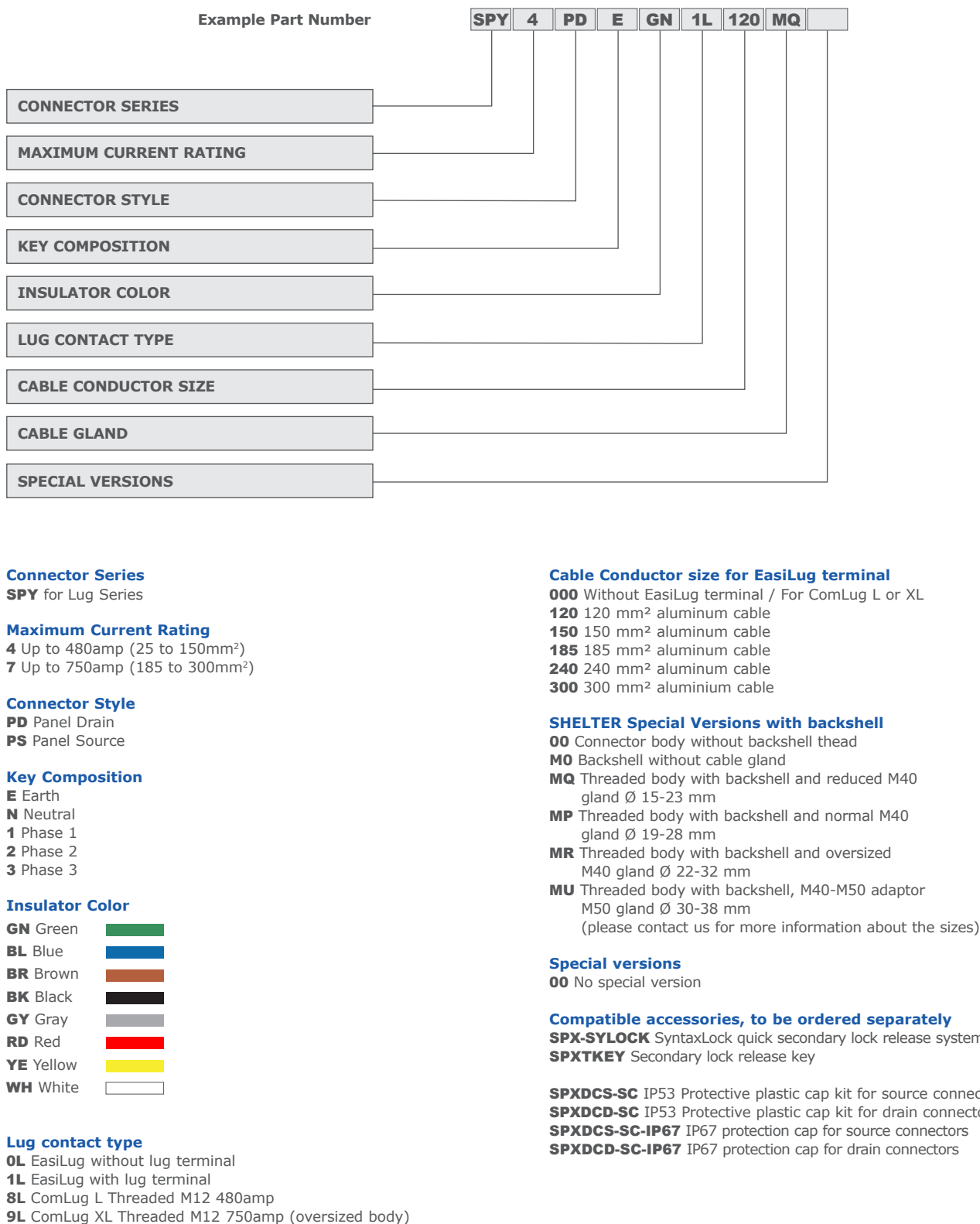

# VALENTINI

Via Asti 84/A | 10098 Rivoli (TO) Italy  
Tel: + 39 011 9594160

info@syntaxnet.it  
[www.valentininet.com](http://www.valentininet.com)



**SYNTAX**

is a Valentini SRL registered trademark